

e-STUDIO 16 / 20 / 25

OPERATOR'S MANUAL FOR FACSIMILE FUNCTION



For U.S.A. only

WARNING FCC Notice: Part 15

This terminal has been tested and found to comply with the limits for a Class A digital device, pursuant to Part 15 of the FCC Rules. These limits are designed to provide reasonable protection against harmful interference when the equipment is operated in a commercial environment. This equipment generates, and can radiate radio frequency energy and, if not installed and used in accordance with this guide, may cause harmful interference to radio communications. Operation of this terminal in a residential area is likely to cause harmful interferences in which case the user will be required to correct the interference at his/her own expense.

WARNING FCC Notice: Part 68

This equipment complies with Part 68 of the FCC Rules. On the rear of this equipment is a label that contains, among other information, the FCC Registration Number and ringer equivalence number (REN) for this equipment. If requested, this information must be provided to the telephone company.

The REN is used to determine the quantity of devices that may be connected to the telephone line. Excessive REN's on the telephone line may result in the devices not ringing in response to an incoming call. In most, but not all areas, the sum of the REN's should not exceed five (5.0). To be certain of the number of devices that may be connected to the line, as determined by the total REN's contact the telephone company to determine the maximum REN for the calling area.

If your facsimile machine causes harm to the telephone network, the telephone company will notify you in advance that temporary discontinuance of service may be required. But if advance notice is not practical, you will be notified as soon as possible, also, you will be advised of your right to file a complaint with the FCC if you believe it is necessary.

The telephone company may make changes in its facilities, equipment, operations, or procedures that could affect the operation of the equipment. If this happens, the telephone company will provide advance notice in order for you to make the necessary modifications in order to maintain uninterrupted service.

If you experience trouble with this facsimile machine, please contact your authorized Toshiba dealer for repair/warranty information. If the trouble is causing harm to the telephone network, the telephone company may request you remove the equipment from the network, until the problem is resolved.

This equipment may not be used on coin service provided by the telephone network, connection to Party Line Service is subject to state tariffs. (Contact the state public utility commission, or corporation commission for information.)

This device is equipped with a USOC RJ11C connector.

THE TELEPHONE CONSUMER PROTECTION ACT: The Telephone Consumer Protection Act of 1991 makes it unlawful for any person to use a computer or other electronic device to send any message via a telephone fax machine unless such a message clearly contains in a margin at the top or bottom of each transmitted page or on the first page of the transmission, the date and time it is sent and an identification of the business or other entity, or other individual sending the message and the telephone number of the sending machine or such business, other entity, or individual.

In order to program this information into your fax machine, you should complete the setup procedures listed for station ID number and name on page 4-18 in this manual.

This equipment is hearing aid compatible.

TOSHIBA AMERICA BUSINESS SOLUTIONS, INC.

Electronic Imaging Division
2 Musick, Irvine, CA 92618-1631

For Canada only

NOTICE: The Industry Canada label identifies certified equipment. This certification means that the equipment meets telecommunications network protective, operational and safety requirements as prescribed in the appropriate Terminal Equipment Technical Requirements document(s). The Department does not guarantee the equipment will operate to the user's satisfaction.

Before installing this equipment, users should ensure that it is permissible to connect a facsimile to the facilities of their local telecommunications company. The equipment must also be installed using an acceptable method of connection. The customer should be aware that compliance with the above conditions may not prevent degradation of service in some situations.

Repairs to certified equipment should be coordinated by a representative designated by the supplier. Any repairs or alterations made by the user to this equipment, or equipment malfunctions, may give the telecommunications company cause to request the user to disconnect the equipment.

Users should ensure for their own protection that the electrical ground connections of the power utility, telephone lines and internal metallic water pipe system, if present, are connected together. This precaution may be particularly important in rural areas.

CAUTION: Users should not attempt to make such connections themselves, but should contact the appropriate electric inspection authority, or electrician, as appropriate.

The Ringer Equivalence Number of your facsimile is 0.3.

NOTICE: The Ringer Equivalence Number (REN) assigned to each terminal device provides an indication of the maximum number of terminals allowed to be connected to a telephone interface. The termination on an interface may consist of any combination of devices subject only to the requirement that the sum of the Ringer Equivalence Numbers of all the devices does not exceed 5.

AVIS: L'étiquette d'Industrie Canada identifie le matériel homologué. Cette étiquette certifie que le matériel est conforme aux normes de protection, d'exploitation et de sécurité des réseaux de télécommunications, comme le prescrivent les documents concernant les exigences techniques relatives au matériel terminal. Le Ministère n'assure toutefois pas que le matériel fonctionnera à la satisfaction de l'utilisateur.

Avant d'installer ce matériel, l'utilisateur doit s'assurer qu'il est permis de le raccorder aux installations de l'entreprise locale de télécommunication. Le matériel doit également être installé en suivant une méthode acceptée de raccordement. L'abonné ne doit pas oublier qu'il est possible que la conformité aux conditions énoncées ci-dessus n'empêche pas la dégradation du service dans certaines situations.

Les réparations de matériel homologué doivent être coordonnées par un représentant désigné par le fournisseur. L'entreprise de télécommunications peut demander à l'utilisateur de débrancher un appareil à la suite de réparations ou de modifications effectuées par l'utilisateur ou à cause de mauvais fonctionnement.

Pour sa propre protection, l'utilisateur doit s'assurer que tous les fils de mise à la terre de la source d'énergie électrique, des lignes téléphoniques et des canalisations d'eau métalliques, s'il y en a, sont raccordés ensemble. Cette précaution est particulièrement importante dans les régions rurales.

Avertissement: L'utilisateur ne doit pas tenter de faire ces raccordements lui-même; il doit avoir recours à un service d'inspection des installations électriques, ou à un électricien, selon le cas.

L'indice d'équivalence de la sonnerie de ce matériel 0.3.

AVIS: L'indice d'équivalence de la sonnerie (IES) assigné à chaque dispositif terminal indique le nombre maximal de terminaux qui peuvent être raccordés à une interface. La terminaison d'une interface téléphonique

peut consister en une combinaison de quelques dispositifs, à la seule condition que la somme d'indices d'équivalence de la sonnerie de tous les dispositifs n'excède pas 5.

TOSHIBA OF CANADA LIMITED

Office Product Group
191 McNABB STREET
MARKHAM, ONTARIO L3R 8H2

For New Zealand only

"The grant of a Telepermit for any item of terminal equipment indicates only that Telecom has accepted that the item complies with minimum conditions for connection to the network. It indicates no endorsement of the product by Telecom, nor does it provide any sort of warranty. Above all, it provides no assurance that any item will work correctly in all respects with another item of Telepermitted equipment of a different make or model, nor does it imply that any is compatible with all of Telecom's network services."

"This equipment is not capable, under all operating conditions, of correct operation at the higher speeds for which it is designated. Telecom will accept no responsibility should difficulties arise in such circumstances."

"This equipment should not be used any circumstances which may constitute a nuisance to other Telecom customers."

"Not all telephones will respond to incoming ringing when connected to the extension socket."

"The decadic (or pulse) dialing on this device is unsuitable for use on the telecom network in New Zealand."

"This device does not support Faxability."

TOSHIBA (AUSTRALIA) PTY LIMITED

17th Floor
296 Queen Street
Auckland
New Zealand
Phone : 64 9 307 0279

PREFACE

Thank you for purchasing the Toshiba GD-1060 Fax kit for e-STUDIO16/20/25. This Operator's Manual describes the following:

- how to correctly use the e-STUDIO16/20/25 FAX functions
- how to send and receive FAXes
- how to inspect the FAX unit
- how to remedy trouble

Before using the digital copier, thoroughly read and understand this Operator's Manual. Keep this Operator's Manual in a handy place for future reference.

* This Operator's Manual applies to the e-STUDIO16/20/25 facsimile function.

* When the digital copier is used as a copier and a printer, be sure to read the Operator's Manual (for Copying Function) and Operator's Manual (for Printer Function).

■ To ensure correct and safe use of the Toshiba Digital Copier e-STUDIO16/20/25, this Operator's Manual describes safety precautions according to the following three levels of warning:

The meaning of these signal words are as follows. Before reading this Operator's Manual, you should fully understand the meaning and importance of these signal words.

Warning — Indicates a potentially hazardous situation which, if not avoided, could result in death, serious injury, or serious damage, or fire in the equipment or surrounding assets.

Caution — Indicates a potentially hazardous situation which, if not avoided, may result in minor or moderate injury, partial damage of the equipment or surrounding assets, or loss of data.

Note — Indicates a procedure you should follow to ensure the optimal performance of the digital copier and problem-free copying.

Tip — Describes information useful to know when operating the digital copier.

Advice — Describes an operation you should follow to maintain the digital copier in good working order.

For European models only:

Warning

This is a Class A product. In a domestic environment, this product may cause radio interference in which case the user may be required to take adequate measures.

- 1 Do not touch the connector terminal when disconnecting the cables of peripheral equipment.
2. Before opening any covers or removing any units from the copier, discharge the static electricity from your body by touching a metal part of the copier.

This product is carrying the CE-Mark in accordance with the related European Directives. Responsible for CE-marking is Toshiba Europe GmbH, Carl-Schurz-Str. 7, 41460 Neuss, Germany. Phone +49-2131-1245-0.

COPYRIGHT 2000
TOSHIBA TEC CORPORATION

Features of the e-STUDIO16/20/25 FAX Functions

- **Super G3 High-speed Communications**

Provides State-of-the Art V.34 modem technology for worldwide compatibility at speeds up to 33,600 bits per second.

- **JBIG Encoding Systems**

Compatible for ITU-T85 (FAX JBIG)

- **Plain paper recording**

Plain paper is used as the FAX output paper. This means that FAX output from the digital copier can be stored for a long time as business documents. You can also write on and sign them.

- **300 destination telephone directory**

- **Dual access**

You can use the fax image memory to carry out the following:

- (1) Original storage during another memory TX
- (2) Original storage during reception
- (3) Copying during memory TX
- (4) Reception storage during copying
- (5) Reception storage during another reception output
- (6) Auto receive during printing of lists
- (7) Memory transmission during printing of reports
- (8) Internet FAX when the option board is installed.

Tip

“Memory transmission” and “memory reception” refers to sending and receiving originals in image memory.

- **High-resolution (U-FINE) mode**

Detailed technical drawings, fine text and photographs can be sent clearly at a resolution of 16 dots/mm x 15.4 lines/mm and 256 level halftone.

- **Multi-address transmission**

You can send the same originals to up to 475 remote FAXes in a single operation by direct dialing, or by specifying remote FAXes using the speed dials, groups, or one touch keys.

- **Weekly timer mode**

The printer heater is turned OFF during predetermined periods so that you can save energy.

- **A3 transmission and recording**

You can send LD (A3)-size originals such as technical drawings at their original size. A3-size originals received on the FAX can also be output at their original size.

- **High-speed scanning***

LT-R (A4-R)-size originals are scanned in about 1.3 seconds (e-STUDIO16), 1.8 seconds (e-STUDIO20/25).

- **Duplex transmission**

You can scan two-sided originals on the reversing automatic document feeder and send them in page order.

- **User friendly guidance**

Operation guidance is shown clearly on the message display. The display shows, for example, the method for changing the communication mode, or how to clear the paper jam.

- **Expandable by adding a wide range of options**

You can also add on a job separator for selecting different trays for outputting FAX received originals, copies and printer outputs. So you can customize your digital copier to suit your particular requirements.

* For ADF condition.

TABLE OF CONTENTS

PREFACE	4
Features of the e-STUDIO16/20/25 FAX Functions	5
TABLE OF CONTENTS	6
PRECAUTIONS	8
When a Power Failure Occurs	8

DESCRIPTION OF THE DIGITAL COPIER

1. DESCRIPTION OF THE OPTIONAL EQUIPMENT	1-3
e-STUDIO16	1-3
e-STUDIO20/25	1-4
2. MAIN COMPONENTS	1-5
3. CONNECTING THE CABLES	1-7
4. DESCRIPTION OF THE CONTROL PANEL	1-8
Function Keys	1-10

BASIC OPERATION

1. SEND MODES	2-3
2. RECEIVING MODES	2-5
3. ABOUT ORIGINALS	2-6
Original Size	2-6
Original Scanning Range	2-6
How to Switch Over to the FAX Mode	2-7
When Placing the Original on the Glass	2-8
Placing the Originals on the Automatic Document Feeder (optional ADF or RADF is installed)	2-8
Precautions When Feeding Originals	2-8
4. PREPARING FOR TRANSMISSION	2-9
5. HOW TO SET SCANNING CONDITIONS	2-10
How to Set the Resolution	2-10
How to Set Image Quality Mode	2-11
How to Set Image Density	2-12
Automatic Image Density Mode Setting Procedure	2-12
Manual Image Density Mode Setting Procedure	2-13
6. SETTING THE SCANNING CONDITIONS FOR EACH PAGE	2-14
Setting Scanning Conditions for Each Page	2-14
7. SPECIFYING THE REMOTE FAX	2-16
Keypad Dialing	2-16
Pause Key	2-17
Tone Key	2-17
Abbreviated Dialing	2-18
Alphabet Dialing	2-19
Group Dialing	2-20
One Touch Dialing	2-21
Dialing by REDIAL/PAUSE Key	2-21
8. SENDING ORIGINALS (MEMORY TX)	2-22
Memory TX	2-23
9. SENDING ORIGINALS (DIRECT TX)	2-24
Direct TX by Default Setting	2-25
Temporary Direct TX	2-25
On-hook Transmission	2-26
Off-hook Transmission (External Telephone Dialing)	2-27

10. CHECKING TRANSMISSION RESULTS	2-28
Checking Transmission Results on the Message Display	2-28
Checking Transmission Results by Printing Reports	2-29
Checking Reserved Transmissions by Printing Reports	2-30
11. CANCELING TRANSMISSIONS	2-31
Canceling transmissions (during scanning)	2-31
Canceling Reserved Memory Transmissions	2-31
Canceling Memory Transmissions (during transmission)	2-31
Canceling Direct Transmission	2-32
12. RECEPTION-TYPES OF AUTO RECEPTION MODE	2-33
Setting AUTO RECEIVE Modes	2-33
AUTO RECEIVE is selected:	2-33
MANUAL RECEIVE is selected:	2-33
Outputting Originals Stored in the Memory	2-35
13. MEMORY RX	2-35
Memory RX Setting	2-35
14. USING THE TELEPHONE	2-36
On-hook Dialing	2-36
Off-hook Dialing (External Telephone)	2-37
Sending a Tone	2-37

ADVANCED FEATURES

1. DELAYED COMMUNICATION (TIME DESIGNATION)	3-3
2. PRIORITY TRANSMISSION (PRIORITY TX)	3-4
3. SENDING TWO-SIDED ORIGINALS	3-5
4. LOW SPEED TRANSMISSION	3-6
5. MULTI-ADDRESS TRANSMISSION (BROADCASTING)	3-7
Multi-Key Quick Broadcast	3-7
Group Broadcast Transmission	3-8
6. MAILBOX (ITU-T COMPATIBLE)	3-9
Setting Up an Open Mailbox	3-10
Deleting an Open Mailbox	3-11
Reserving a Document to a Mailbox (Local Hub)	3-12
Printing a Document from a Mailbox (Local Hub)	3-13
Sending a Document to a Mailbox (Remote Hub)	3-14
Retrieving (Polling) a Document from a Mailbox (Remote Hub)	3-15
Deleting Documents in a Mailbox (Local Hub)	3-16
Relay Transmission, Relay-Relay Transmission Overview	3-17
7. RELAY TRANSMISSION	3-17
Setting Up a Relay Box	3-19
Deleting a Relay Box	3-21
Relay Transmission to a Remote Hub	3-22
8. POLLING COMMUNICATIONS	3-23
Polling Reservation	3-23
Individual Polling RX	3-25
For details on how to specify remote FAXes using Multi-polling RX	3-26
Turnaround Polling	3-27
Continuous Polling	3-28
Clear the Settings of the Continuous Polling	3-30
9. CHAIN DIALING	3-31

TABLE OF CONTENTS (Cont.)

ENTERING & SETTING ITEMS

1. ENTERING CHARACTERS	4-3
Keys used for Character Entry	4-3
Special Character Table	4-4
Entering Characters	4-5
Correct Entered Characters	4-6
2. ENTERING THE REMOTE FAX NUMBER	4-7
Entering to TEL LIST	4-7
Entering Abbreviated Dialer Registration	4-8
Entering One Touch Dialer Registration	4-10
Groups Number Registration	4-12
Correcting Groups (Modify the Remote Station)	4-14
Correcting Groups (Delete the Remote Station)	4-16
Deleting Groups	4-17
3. ENTERING VARIOUS FUNCTIONS	4-18
Terminal ID Entry	4-18
Dial Type Entry	4-19
Exchange Type Entry (EU MODEL ONLY)	4-20
Line Monitor	4-21
Temporary Line Monitor Change	4-21
Receive Interval Setting	4-22
ECM Setting	4-22
Temporary ECM Change	4-23
Default Setting for Document Mode	4-24
Redial Mode Setting	4-25
Default Setting for Memory Transmission	4-26
Temporary Security TX Change	4-27
Security TX (Transmission) Setting	4-27
Cover Sheet Registration	4-28
Attaching or Printing Cover Sheet	4-29
Setting Recovery Transmission	4-31
Sending Recovery Transmission	4-32
TTI (Transmit Terminal ID) Print Setting	4-33
Send After Scan Default Setting	4-34
Enabling or Disabling Send After Scan Temporarily	4-35
Account Codes	4-36
Account Code Entry	4-37
Separator Page Setting	4-38
Secure RX Security Code Setting	4-39
Secure RX Activation Period Setting	4-40
Secure RX Manual Activation	4-42
Secure RX Print	4-43
Reception Reduction Setting	4-44
Reception Discard Setting	4-44
Privileged Reception	4-45
RTI (Remote Terminal ID) Print Setting	4-46
Long Original Setting	4-47
Setting the Page Count	4-48
Pin Mask	4-49
Dialing with Sub-address	4-50
4. OUTPUTTING LISTS & REPORTS	4-52
List & Report Options Setting	4-52
Reception Journal Setting	4-53
Direct Transmission Report Setting	4-54

Memory Transmission Report Setting	4-55
Multi-Address Transmission Report Setting	4-56
Multi-Polling Report Setting	4-56
Relay Originator Report Setting	4-57
Relay Station Transmission Report Setting	4-57
Reception List Setting	4-58
Transmission/Relay Destination Report Setting	4-58
Tel List	4-59
Reservation List	4-59
Department Code List	4-59
List and Report Printing Procedure	4-59
Function List	4-60
Mailbox/Relay Box List	4-60
Fax Option List	4-60
Menu List (PROGRAM)	4-60
List and Report Print Format	4-61
Transmission/Reception Journal	4-61
Transmission Report	4-64
Memory Transmission Report	4-65
Multi-Address Transmission Report	4-66
Multi-Polling Report	4-68
Relay Transmission Originator Report	4-70
Relay Station Report	4-71
Relay Transmission Relay Station Report	4-72
Relay Transmission Relay End Terminal Report	4-74
Mailbox/Relay Box List	4-75
Department Control List	4-76
Reservation List	4-77
Alphabetical Sort List	4-79
Abbreviated Dial Number List	4-80
Group Number List	4-82
One Touch Number List	4-83
Function List	4-84
Fax Option List	4-85
Menu List (PROGRAM)	4-86
Power Failure List	4-87

TROUBLESHOOTING

1. TROUBLESHOOTING	5-3
When the Graphic Symbols Flash	5-3
Error Message	5-4
Transmission Trouble	5-6
Reception Trouble	5-7
Error Codes Printed on Reports	5-8

REMOTE SERVICE

1. RDC (Remote Diagnosis Configuration) Service	6-3
2. AUTOMATIC SUPPLIES ORDER	6-4
Automatic Supplies Order Setting	6-4

TABLE OF CONTENTS (Cont.)

SPECIFICATIONS

1. SPECIFICATIONS 7-3

INDEX

PRECAUTIONS

When a Power Failure Occurs

- In the event of a power failure, neither facsimile nor telephone functions of the unit are available.
- In the event a power failure occurs (or the power to the unit has been disconnected), functions and unit operation will not be possible. Any document data stored in memory will be retained for a period of approximately 2 hours (if the internal battery is fully charged). This period may be shortened if optional memory has been installed. On exceeding that time limit, the following items will be erased:
 - Document data stored in memory for Transmission, Substitute Memory Receptions, etc.
 - The address and designated time of each Timer Transmission, Timer Polling Reception, etc.
 - Programmed data such as the clock, Auto Dial Numbers and user configurations will not be erased. This data is supported by second battery with a maximum five year life. (from time of manufacture.)
 - In the event that document data has been erased due to a power failure, the message "POWER FAILURE" is displayed on the LCD and a Power Failure Report is issued once the power is restored. (► See page 4-87.)



DESCRIPTION OF THE DIGITAL COPIER

1. DESCRIPTION OF THE OPTIONAL EQUIPMENT	1-3
e-STUDIO16	1-3
e-STUDIO20/25	1-4
2. MAIN COMPONENTS	1-5
3. CONNECTING THE CABLES	1-7
4. DESCRIPTION OF THE CONTROL PANEL	1-8
Function Keys	1-10

1. DESCRIPTION OF THE OPTIONAL EQUIPMENT

e-STUDIO16

- ① Automatic document feeder (MR-2012)
- ② Reversing automatic document feeder (MR-3011)

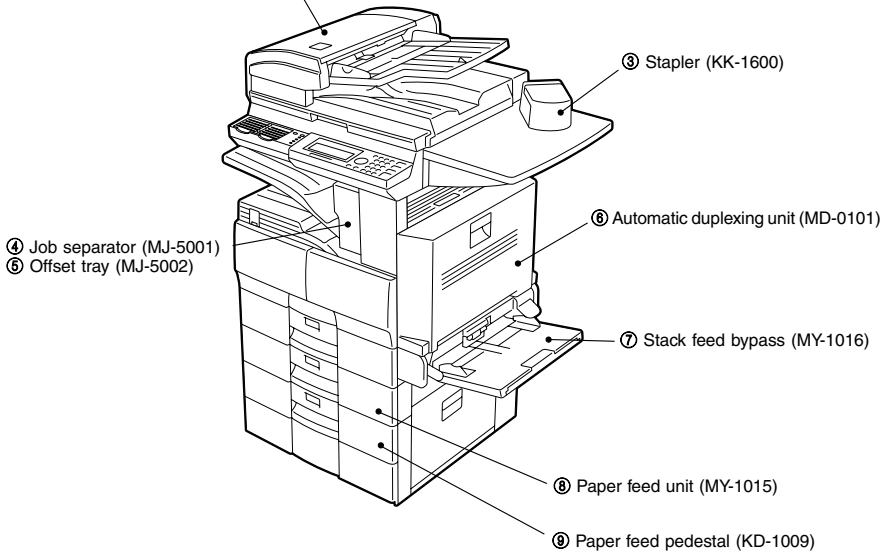

- **Print Function with Job Separator (option) Attached**

When the job separator is attached, received faxes are output onto the upper tray and copied sheets are output on the lower tray. The job separator is convenient since copies and faxes can be output separately.

- **Print Function with Stack Feed Bypass (option) Attached**

Even though the stack feed bypass is attached, it cannot be used for receiving faxes.

1. DESCRIPTION OF THE OPTIONAL EQUIPMENT (Cont.)

e-STUDIO20/25

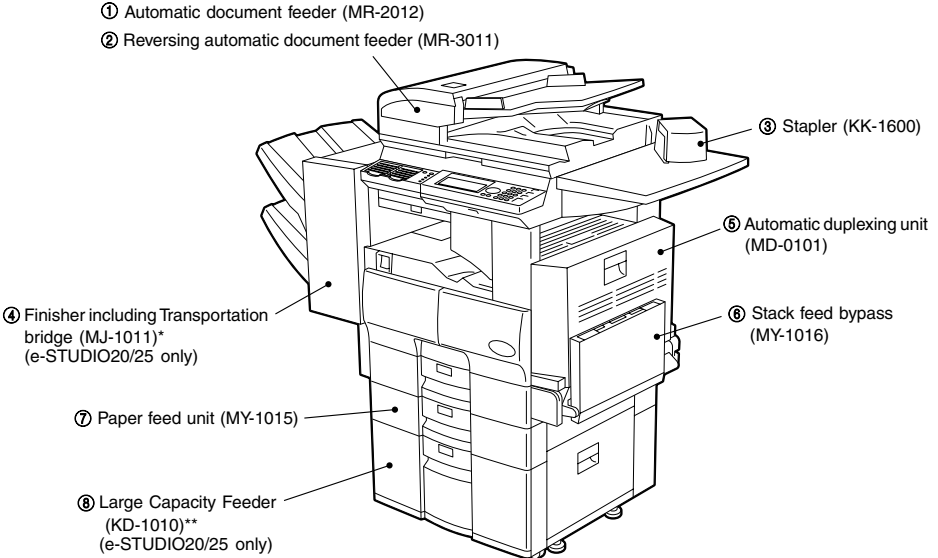

* The Job separator (MJ-5001) or Offset tray (MJ-5002) can be installed in place of the Finisher.

** The Paper feed pedestal (KD-1009) can be installed in place of the Large capacity feeder (KD-1010). Furthermore, the Cassette module (MY-1017) (option for e-STUDIO20/25) can be installed in the KD-1009.

• Print Function with Job Separator (option) Attached

When the job separator is attached, received faxes are output onto the upper tray and copied sheets are output on the lower tray. The job separator is convenient since copies and faxes can be output separately.

• Print Function with Finisher (option for the e-STUDIO20/25) Attached

Even if the finisher is attached, received faxes are output onto the central output tray.

• Print Function with Stack Feed Bypass (option) Attached

Even though the stack feed bypass is attached, it cannot be used for receiving faxes.

2. MAIN COMPONENTS

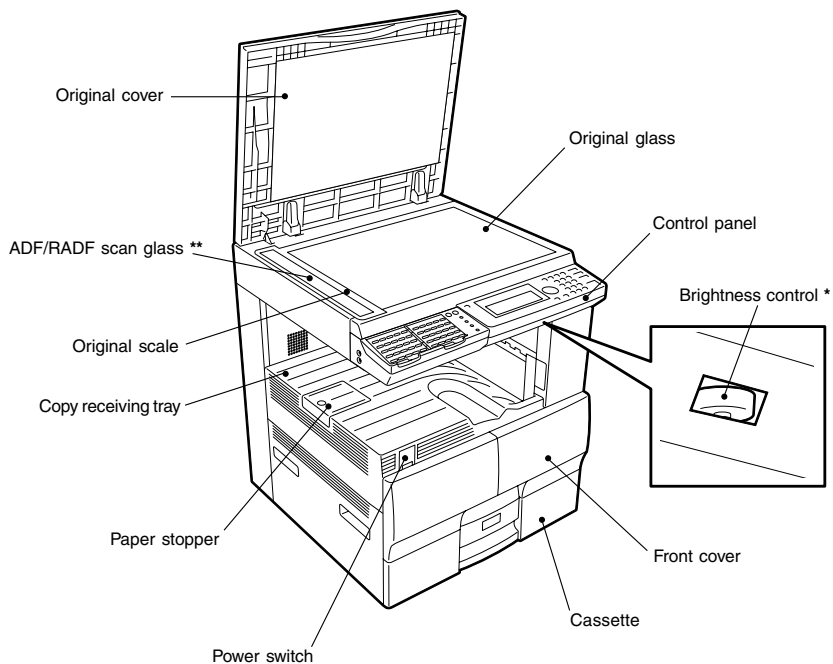

*** Brightness control**

Used to adjust the brightness of the message display panel.

**** ADF - Automatic document feeder**

RADF - Reversing automatic document feeder

2. MAIN COMPONENTS (Cont.)

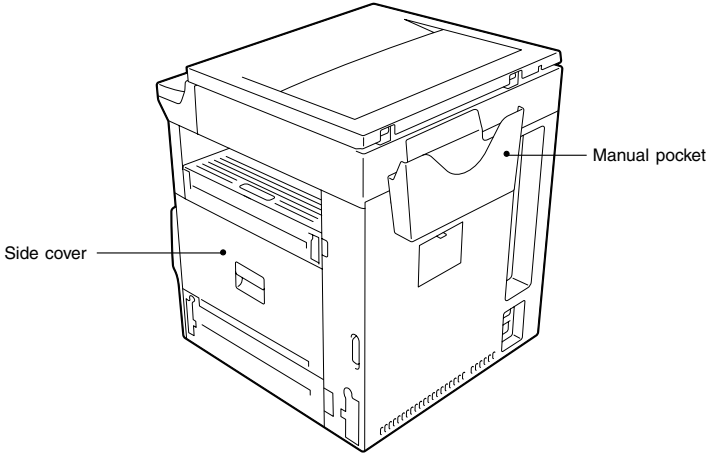

3. CONNECTING THE CABLES

Before you connect cables, make sure that the power switch is in the OFF position.

Connect the telephone line to the connector marked "LINE."

Connect the external telephone to the connector marked "TEL."

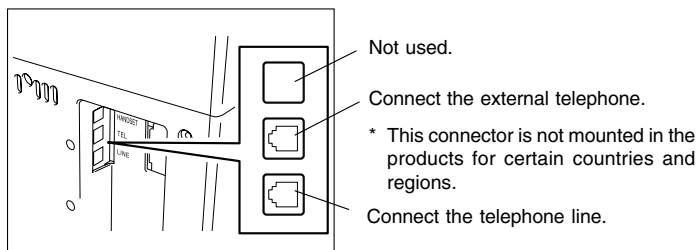

Note

Do not connect two or more telephones to one telephone connector.

4. DESCRIPTION OF THE CONTROL PANEL

1

① **One Touch keys (1-75), Function keys, and Keyboard**

A description of the One Touch keys, Function keys, and Keyboard is given on page 1-10, 4-3.

② **SCAN key**

Used in "Internet Fax Function."

③ **FAX key**

Press this key to switch from the other modes to the FAX mode. This manual describes the settings and operation in the FAX mode in detail. Please refer to the "Operator's Manual for E-mail Function" for information about the setting and operation for the E-mail.

④ **COPY key**

Press this key to switch from the other modes to the COPY mode.

Please refer to the "Operator's Manual for Copying Function" for further information about the settings and operation in the COPY mode.

⑤ **FINISHING key**

You can specify how you would like to output copies (including Sort and Offset).

⑥ **ZOOM key**

You can specify the scaling factor for copying.

⑦ **PAPER SUPPLY key**

You can specify from which paper cassette you would like to feed paper for making a copy.

⑧ **LIGHT/DARK key**

Use this key to specify the scanning density.

⑨ **MONITOR key**

Used to enable the speaker monitor, for monitoring call progress during non memory transmission.

⑩ **REDIAL/PAUSE key**

Jobs (max. 100 telephone numbers), which are ready to be re-sent in the transmission-memory appear on the message display panel. You can re-fax each by selecting a telephone number. Or, use this key to enter a pause between telephone digits when entering a remote facsimile number.

⑪ **SPEED DIAL key**

Use to accessing Abbreviated, Alphabet, or Group dialing telephone directories.

⑫ **RESOLUTION key**

Use this key to change the scanning resolution.

⑬ **Paper Jam lamp**

This lamp blinks when an original or recording paper is jammed.

⑭ **Recording Paper lamp**

This lamp blinks in the FAX mode when no paper is loaded in any of the paper cassettes.

⑮ **Toner lamp**

This lamp illuminates when the toner is about to run out or blinks when the toner runs out completely.

⑯ **PC Communication lamp**

This lamp blinks while the copier is serving as a printer and communicating with your computer, or while it is communicating as a local scanner.

⑰ **FAX Communication lamp**

This lamp blinks when communicating using the phone line.

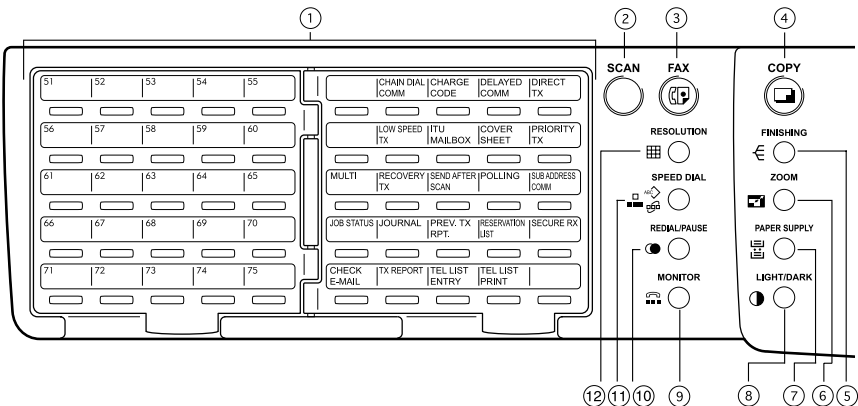

18 Arrow keys

Use these keys to select a desired setting option or to enter a desired name or value in the PROGRAM mode or COMM. Option.

19 PRINTER key

Use this key to adjust the printer settings or perform printing automatically.

20 MAIN MENU key

Press this key to switch from the PROGRAM mode to the MAIN MENU. (COPY, FAX or SCAN mode.)

21 PROGRAM key

Use this key to program the initial settings and default settings in the FAX mode.

22 INTERRUPT key and INTERRUPT lamp

This key and lamp are not used in the FAX mode.

23 SUPER ENERGY**SAVER key and SUPER ENERGY SAVER lamp**

Press this key to enter or exit the Super Energy Saver Mode. Illuminated when the facsimile is in the Super Energy Saver Mode.

24 FUNCTION CLEAR key

Clear all items selected in the FAX mode such as COMM. Option.

25 CLEAR/STOP key

Use this key to correct the dialed remote FAX number when sending an original or to stop an operation.

26 START key

Press this key to start scanning of the originals to the memory or direct TX.

27 Dial keypad

Use these keys to enter a telephone/facsimile number or to set the ID number, etc. Used to enter the item numbers for the selection in "PROGRAM MODE" and "COMM OPTIONS."

28 SET key

Use this key to accept the data that you have entered in the PROGRAM mode or COMM. Option.

29 CANCEL key

Use this key to return to a previous menu in the PROGRAM mode or COMM. Option.

30 IMAGE MODE key

You can switch between the image modes (Photo, Text/Photo and Photo) for scanning. The lamp of the currently selected image mode illuminates.

31 Message Display Panel

The Message Display Panel indicates the FAX status. It also shows you the operational procedures or settings by a brief sentence or icons

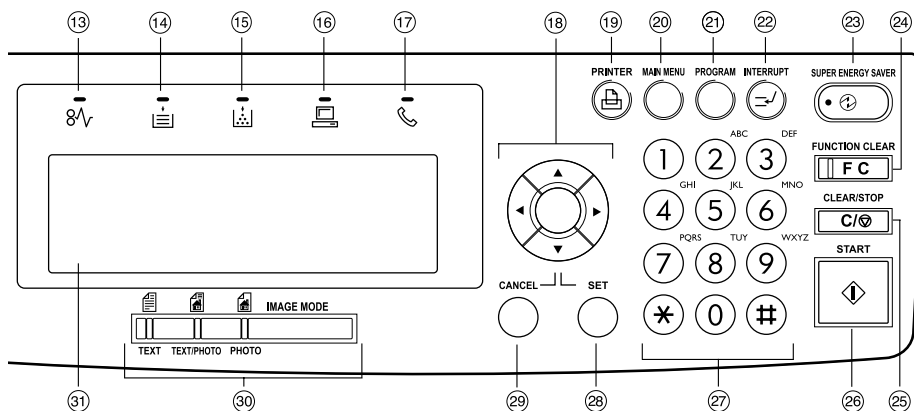

4. DESCRIPTION OF THE CONTROL PANEL (Cont.)

Function Keys

The Function keys are located on the left side of the Control Panel and enable the following frequently used functions and settings by pressing the desired key.

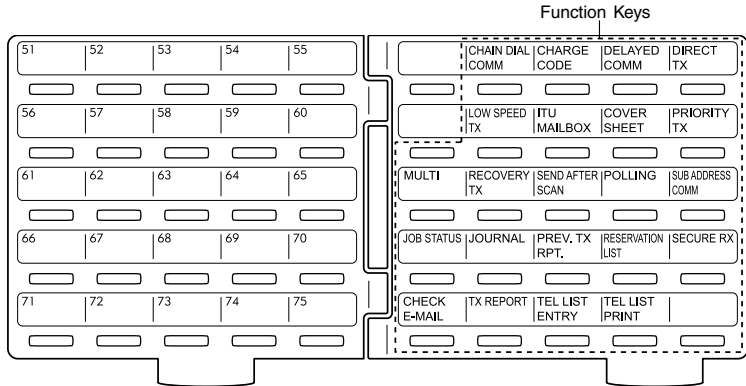

Keyboard

Used to enter alphabetic characters when setting the speed dials, etc. (See page 4-3.)

One Touch keys (1-75)

Used to select telephone/facsimile number by simply pressing these keys.

CHAIN DIAL COMM

Used to dial a remote party using Chain Dialing. (► see page 3-31.)

CHARGE CODE

Allows entry of a Charge Code at the time of dialing or during Abbreviated Dial and One Touch Dial programming. (► see page 4-49.)

DELAYED COMM

Schedules a delayed communication job to be performed at a designated time. (► see page 3-3.)

DIRECT TX

Allows transmission direct from the document glass or the document feeder without the use of memory. (► see page 2-25.)

LOW SPEED TX

Used to select a lower transmission speed to transmit a document when poor line conditions are expected, such as when transmitting to a foreign country that can only accept low speed data. (► see page 3-6.)

ITU MAILBOX

Used for Mailbox Communications or Relay, Transmission with remote facsimiles that support the ITU-T F-code functions. (► see page 3-10.)

COVER SHEET

Used to attach a cover sheet to a document to be transmitted. (► see page 4-29.)

PRIORITY TX

Sends pages set on the document glass or in the document feeder ahead of all previously scheduled transmissions. (► see page 3-4.)

MULTI

Used to create a manual grouping for multi-address transmission. (► see page 3-7.)

RECOVERY TX

Recovers from memory and sends incomplete transmissions. (► see page 4-32.)

SEND AFTER SCAN

Used to select whether the dialing starts while the machine is scanning the documents or after the machine has scanned all documents to memory. (► see page 4-35.)

POLLING

Designate polling communication. (► see page 3-23.)

SUB ADDRESS COMM

Add sub-address digits to the remote facsimile number for routing or security. (► see page 4-50.)

JOB STATUS

Used to confirm the status of the job or canceling a job. (► see page 2-31.)

JOURNAL

Used to print a communication journal. (► see page 2-29.)

PREV. TX RPT

Displays or prints the result of latest 150 transmission jobs.
(► see page 2-28.)

RESERVATION LIST

Prints a Job Reservation List.
(► see page 2-30.)

SECURE RX

Enables or disables Secure RX.
(► see pages 4-42 and 4-43.)

CHECK E-MAIL

Used to receive an E-mail immediately. (Requires optional GD-1070 (Internet FAX Kit) and GF-1110 (NIC Kit) be installed.)

TX REPORT

Print a transmission report for one job.

TEL LIST ENTRY

Used to register Abbreviated, One Touch, Group, and Relay Group Dialing numbers.
(► see page 4-8, 4-10 and 4-12.)

TEL LIST PRINT

Prints desired telephone/facsimile lists. (► see page 4-59.)

BASIC OPERATION

1. SEND MODES	2-3
2. RECEIVING MODES	2-5
3. ABOUT ORIGINALS	2-6
Original Size	2-6
Original Scanning Range	2-6
How to Switch Over to the FAX Mode	2-7
When Placing the Original on the Glass	2-8
Placing the Originals on the Automatic Document Feeder (optional ADF or RADF is installed)	2-8
Precautions When Feeding Originals	2-8
4. PREPARING FOR TRANSMISSION	2-9
5. HOW TO SET SCANNING CONDITIONS	2-10
How to Set the Resolution	2-10
How to Set Image Quality Mode	2-11
How to Set Image Density	2-12
Automatic Image Density Mode Setting Procedure	2-12
Manual Image Density Mode Setting Procedure	2-13
6. SETTING THE SCANNING CONDITIONS FOR EACH PAGE	2-14
Setting Scanning Conditions for Each Page	2-14
7. SPECIFYING THE REMOTE FAX	2-16
Keypad Dialing	2-16
Pause Key	2-17
Tone Key	2-17
Abbreviated Dialing	2-18
Alphabet Dialing	2-19
Group Dialing	2-20
One Touch Dialing	2-21
Dialing by REDIAL/PAUSE Key	2-21
8. SENDING ORIGINALS (MEMORY TX)	2-22
Memory TX	2-23
9. SENDING ORIGINALS (DIRECT TX)	2-24
Direct TX by Default Setting	2-25
Temporary Direct TX	2-25
On-hook Transmission	2-26
Off-hook Transmission (External Telephone Dialing)	2-27

10. CHECKING TRANSMISSION RESULTS	2-28
Checking Transmission Results on the Message Display	2-28
Checking Transmission Results by Printing Reports	2-29
Checking Reserved Transmissions by Printing Reports	2-30
11. CANCELING TRANSMISSIONS	2-31
Canceling transmissions (during scanning)	2-31
Canceling Reserved Memory Transmissions	2-31
Canceling Memory Transmissions (during transmission)	2-31
Canceling Direct Transmission.....	2-32
12. RECEPTION-TYPES OF AUTO RECEPTION MODE	2-33
Setting AUTO RECEIVE Modes	2-33
AUTO RECEIVE is selected:	2-33
MANUAL RECEIVE is selected:	2-33
Outputting Originals Stored in the Memory	2-35
13. MEMORY RX	2-35
Memory RX Setting	2-35
14. USING THE TELEPHONE	2-36
On-hook Dialing	2-36
Off-hook Dialing (External Telephone)	2-37
Sending a Tone.....	2-37

1. SEND MODES

- **Memory TX (▶ See page 2-23.)**

The original automatically starts to be sent after it has been temporarily stored to memory. This mode is useful if you want to return original files immediately. You can also send the same original to two or more remote FAXes (multi-address transmission).

- **Direct TX (▶ See page 2-24.)**

The remote FAX is dialed immediately, and the original will be sent as it is being scanned. This mode is useful if you want to confirm the remote party you are sending to. Originals are not stored to memory, and you can specify only one remote FAX at a time.

- **Keypad dialing (▶ See page 2-16.)**

You can dial the telephone number of the remote FAX directly using the dial keypad.

- **Speed dialing (▶ See page 2-18.)**

You can specify a remote FAX using the Speed Dials registered beforehand.

- **One Touch dialing (▶ See page 2-21.)**

You can specify a remote FAX by pressing a One Touch Key registered beforehand.

- **On-hook dialing (▶ See page 2-26.)**

You can make a telephone call and send originals after confirming dial tone and the number dialed.

When the line is connected to the remote FAX and the high-pitched tone is heard, press the  key to send the original.

You can also use keypad dialing, speed dialing, and one touch dialing.

- **Off-hook dialing (▶ See page 2-27.)**

You can pick up the external telephone handset, make the telephone call and then send originals.

When the line is connected to the remote FAX and the high-pitched tone is heard, press the  key to send the original.

You can also use keypad dialing, speed dialing, and one touch dialing.

- **Delayed communications (▶ See page 3-3.)**

You can send to a specified remote FAX at a specified time.

This mode is useful when you are making use of night-time discounts and sending originals overseas.

- **Priority TX (▶ See page 3-4.)**

You can send a facsimile before any other reserved transmission.

- **Recovery TX (▶ See page 4-32.)**

You can resend a facsimile after the message initially failed to be sent.

- **Group transmission (▶ See page 2-20.)**

You can send the same original to two or more remote FAXes in a single operation.

- **Relay Transmission (▶ See page 3-17.)**

You can send the originals from your FAX to a HUB station, then send them to the end stations.

This mode is useful for saving time and phone charge if you have several stations in one or more regional area.

- **Mailbox Transmission (▶ See page 3-10.)**

You can send document to ITU-T F-code compliant mailboxes in remote facsimiles.

1. SEND MODES (Cont.)

2

- **Polling transmission (▶ See page 3-23.)**

You can store originals in memory, and wait for a request to send the originals from a remote FAX. When a request arrives, the originals are automatically sent to the remote FAX that sent the request. In this way, the remote FAX can receive originals at any convenient time. A password prevents non-admission users from using the machine.

- **Security TX (▶ See page 4-27.)**

You can prevent your FAX from sending to an incorrect remote FAX by using this mode.

- **Multi-address transmission (▶ See page 3-7.)**

You can designate two or more FAXes by using this mode. There are two types of multi-address transmissions; Individual Multi-address transmission and Group Multi-address transmission.

- **Sub-address communications (▶ See page 4-50.)**

This function attaches a sub-address to the standard destination address in the event the remote party requires one.

Three types of sub-addresses can be used (SUB, SEP, and PWD); or any combination of two or three types can be used. After selecting the desired types, the transmission to follow will be sent to the desired address using the designated sub-address.

2. RECEIVING MODES

- **Automatic RX (▶ See page 2-33.)**

FAXes are automatically received when there is an incoming call.

- **Manual RX (▶ See page 2-33.)**

FAXes start to be received when you confirm the call on an external telephone (connected to the TEL jack) and press the  key.

- **Memory RX (▶ See page 2-35.)**

This digital copier stores the information of received originals to memory to ensure communications even if a problem (e.g. a paper jam or no more paper in the digital copier) occurs during reception and prevents the originals from being printed. If an original is received, for example, when the digital copier is out of paper, the received original is automatically stored to memory.

- **Polling RX (▶ See pages 3-25 and 3-26.)**

You ask the remote FAX for transmission, and receive the original that is stored in the remote FAX's memory.

The polling reception has:

- 1) Individual polling reception
- 2) Multi-polling reception

A password can be used (if the remote facsimile is a Toshiba fax).

- **RX reduction (▶ See page 4-44.)**

This mode allows the reduction of the received image if the received original is larger than the recording paper.

- **Secure RX (▶ See page 4-39.)**

This mode allows you to receive the originals to memory until a security code is entered.

- **Privileged RX (▶ See page 4-45.)**

This mode prevents your FAX from receiving originals from unknown parties.

3. ABOUT ORIGINALS

Original Size

The following table shows the size and thickness of originals that can be sent on this copier.

Setting place	Types of original	Original size	Maximum number that can be set	Remarks
Glass	Sheets Three-dimensional objects Books	Letter format: LD, LG, LT, LT-R, ST-R A/B format: A3, A4, A4-R, A5-R, B4		Do not place any heavy object (8.8 lb. or 4 kg or over) on the glass.
Automatic document feeder (optional)	Plain paper, thermal paper (for word processor or fax), long originals, originals with filing holes (2-, 3- and 4-holes): 13 lb. - 29 lb. 50-80 g/m ² (Multi-sheet feeding) 29 lb. - 34 lb. 80-127 g/m ² (1-sheet feeding)	Letter format: LD, LG, LT, LT-R, ST-R, COMP A/B format: A3, A4, A4-R, A5-R, B4, B5, B5-R, FOLIO (*ST/A5 is not available.)	50 originals (13 lb. - 29 lb., 50 - 80 g/m ²) or stacked height of originals 8 mm (0.31 inches) or less	Some of the originals on the left may not be used depending on type or thickness or excessive curl. (For details, consult your service technician.)
Reversing automatic document feeder (optional)	Plain paper, thermal paper (for word processor or fax), long originals, originals with filing holes (2-, 3- and 4-holes) 13 -34 lb. 50 - 127 g/m ² (1-sided original) 13 - 28 lb. 50 - 105 g/m ² (2-sided original)	Letter format: LD, LG, LT, LT-R, ST-R, COMP A /B format: A3, A4, A4-R, A5-R, B4, B5, B5-R, FOLIO (*ST/A5 is not available.)	100 originals (13 - 22 lb. 50 - 80 g/m ²) or stacked height of originals 16 mm (0.63 inches) or less.	Some of the originals on the left may not be used depending on paper quality or thickness, or excessive curl.

Original Scanning Range

The complete area of the originals described above (other than B5, B4, and COMP) is scanned. However, some remote FAXes cannot print the scanned area completely due to its ability. The area to be scanned on B5, B4, and COMP originals is shown in the figure below.

COMP

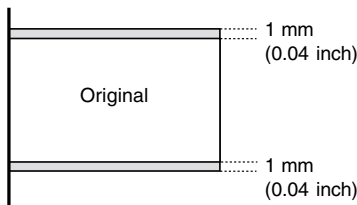

B5, B4

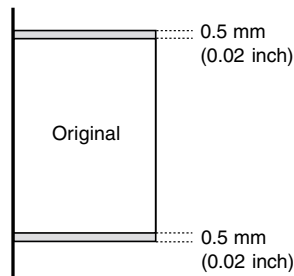

Tip

A4 (LT) originals are automatically rotated and sent as A4-R (LT-R) sized originals.

How to Switch Over to the FAX Mode

- 1 Turn ON the power switch.

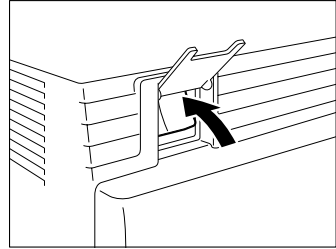

2

- 2 The copier is turned on in the COPY mode.

- The message "READY" indicates that you can make copies at any time.

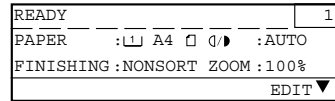

- 3 Press the  key on the control panel to select the FAX function.

Note

- Before carrying out FAX operations, be sure to switch over to the FAX mode.
- You can set up the machine so it will default to the FAX MODE upon turning on the power. For the details, please ask your service personnel.

Tip

- If you leave the digital copier inactive for about 45 seconds, the digital copier automatically returns to the copying mode (Default setting).
- You can switch over to the FAX mode while the digital copier is in the sleep mode.

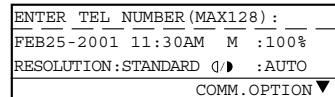
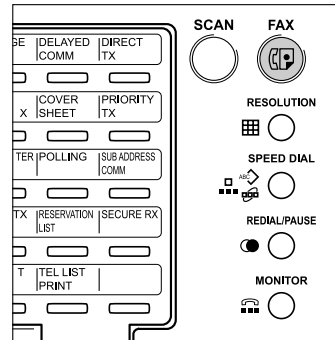

3. ABOUT ORIGINALS (Cont.)

When Placing the Original on the Glass

- 1** Lifting the original cover or the automatic document feeder, place the original on the glass face down and with its bottom towards you and with top left aligned against the original scale.

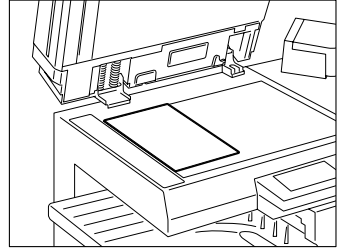

Placing the Originals on the Automatic Document Feeder (optional ADF or RADF is installed)

- 1** After aligning the edges of the originals, set them face up on the original feed tray and adjust the slides to the edges of the originals.

- You cannot mix different sizes of originals such as (Ledger (A3) and Letter (A4)).
- Letter (A4) size originals are rotated 90° so that they are sent as Letter (A4)-R originals.

Important

If you use Memory TX, you can position LT size originals in the standard copier configuration and the copier will automatically re-orientate the image for facsimile transmission. However, if you use Direct TX, On-Hook TX or Off-Hook TX, you must orientate your LT size originals as shown above or they will be reduced or the top and bottom edges will be cut-off by receiving machine.

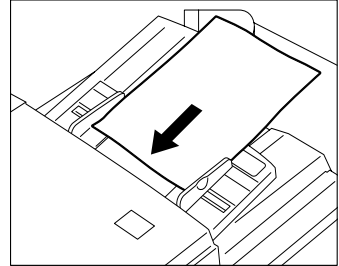

4. PREPARING FOR TRANSMISSION

Order In Which Originals Are Sent to Remote Parties

- When you specify memory TX, the originals start to be scanned from the upper most page, and transmitted beginning with the first scanned page (original placed uppermost).

Precautions When Feeding Originals

Do not use the following types of originals as they tend to be misfeed or become damaged:

- (1) Badly wrinkled or folded originals. In particular, originals whose leading edge are curled may fail to be fed. (4) Clipped or stapled originals



- (2) Originals with carbon paper



- (5) Originals with holes or torn originals



- (3) Taped, pasted or clipped (cut out) originals

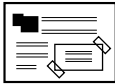

- (6) Damp originals



- (7) OHP film originals

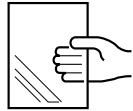

Also, the following originals should be handled carefully:

- (1) Folded or curled originals should be smoothed out before being used.

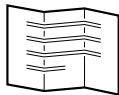

- (2) Originals with the same width can be set at a time. (Do not mix originals with different widths.)



- (3) Originals sticking to each other, or originals that are surface-treated may fail to separate properly.



5. HOW TO SET SCANNING CONDITIONS

How to Set the Resolution

- Set the resolution according to the size of the text in the original that you are to send. If you do not set the resolution, the original is sent at the resolution set in the Default Setting for Document Mode. (▶ See page 4-24.)

STANDARD: Select this setting when the text in the original is regular size.

FINE: Select this setting when the text in the original is small or you are sending a detailed drawing.

U-FINE: Select this setting when the text in the original is particularly small or you are sending a precision drawing.

Tip

If the remote FAX cannot receive originals at the same resolution, the resolution of the sent original is automatically converted before it is sent. The finer the resolution, the longer it takes to send an original.

1 Press the  key.

2 Press the  key with the initial screen shown in the FAX mode.

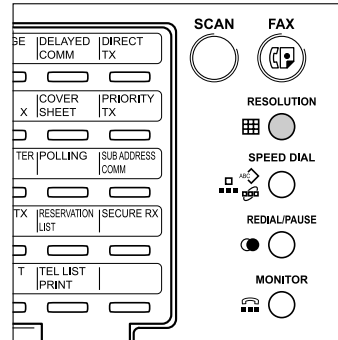

3 Use the  or  key to select the desired resolution mode.

Press the  key to complete the setting.

- To cancel setting midway, press the  key.

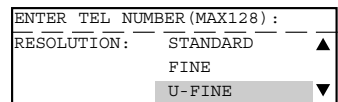
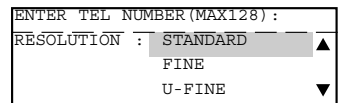

How to Set Image Quality Mode

- Set the image quality mode (TEXT, TEXT/PHOTO, PHOTO) to suit the type of original to be sent.

TEXT mode: Select this setting when sending text originals.

PHOTO/TEXT mode: Select this setting when sending originals containing both text and photos.

PHOTO mode: Select this setting when sending photo originals.

Tip

Transmission time may be longer than TEXT mode, in case of selecting TEXT/PHOTO mode or PHOTO mode.

2

1 Press the  key.

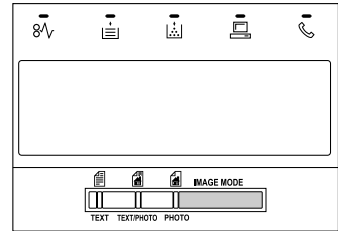

2 Press the  key until the desired mode lamp illuminates.



5. HOW TO SET SCANNING CONDITIONS (Cont.)

How to Set Image Density

- Set the exposure according to the contrast of the original that you are sending.
- There are two ways of selecting image density: by the automatic image density mode or the manual image density mode.
 - In the automatic image density mode, the digital copier automatically judges the contrast of the original, and selects the ideal contrast.
 - In the manual image density mode, you can adjust the contrast manually in 7 stages.

If you are sending a dark original, press the  key to lighten the contrast, and if you are sending a light original, press the  key to darken it.

If you do not set the contrast mode, the original is sent at the contrast adjustment value preset in the transmission mode setting. (▶ See page 4-24.)

Values set here are valid for only one transmission.

Automatic Image Density Mode Setting Procedure

1 Press the  key.

2 Press the  key.

- If the AUTO is already displayed in the message panel, there is no need to set it.

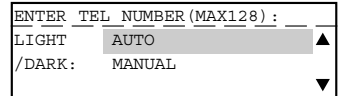
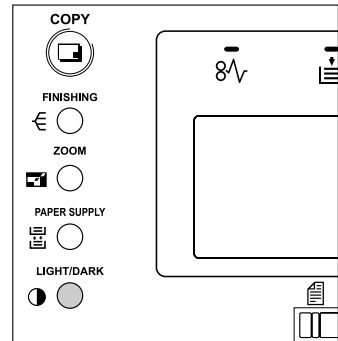

3 Select AUTO by pressing the  key.

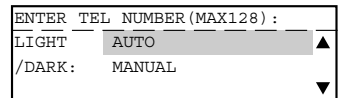

4 Press the  key to complete the setting.

- To cancel setting midway, press the  key.

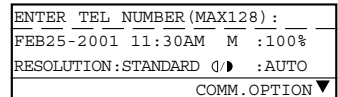

Manual Image Density Mode Setting Procedure

1 Press the  key.

2 Press the  key.

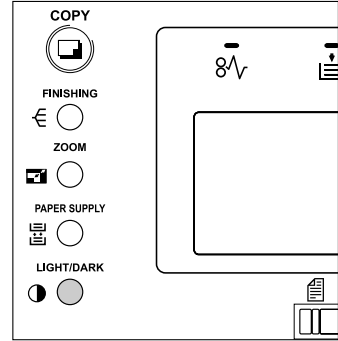

2

3 Select **MANUAL** by pressing the  key and press the  key.

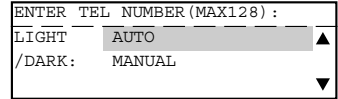

4 Press  or  key to set the image density manually.

- To lighten the contrast, press the  key.

Each press of this key moves the scale to the left to lighten the contrast.

- To darken the contrast, press the  key.

Each press of this key moves the scale to the right to darken the contrast.

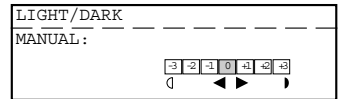
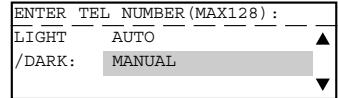

5 Press the  key to complete the setting.

- To cancel setting midway, press the  key twice.

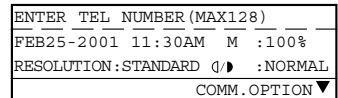

6. SETTING THE SCANNING CONDITIONS FOR EACH PAGE

2

When you want to send multi-page originals by using the original glass, you can change the following scanning conditions for each page:

- Resolution
- Image Mode
- Image Density
- Original size

Tip

When originals are placed on the original feed tray of the optional ADF or RADF, you cannot change the scanning conditions for each page.

- Set the scanning conditions for the first sheet before you press the  key.

Setting Scanning Conditions for Each Page

1 Press the  key.

2 Place the original on the glass.

3 Set the scanning conditions.



4 Specify the remote FAX.

- Abbreviated Dialing ▶ See page 2-18.
- Alphabet Dialing ▶ See page 2-19.
- Group Dialing ▶ See page 2-20.
- One Touch Dialing ▶ See page 2-21.

e-STUDIO16 Go to step 5.

e-STUDIO20/25 → Go to step 6.

5 Select the original size.

- Using the  or  key, select the original size and press the  key.

Select original size	
LT <input type="checkbox"/>	▲
LD <input type="checkbox"/>	
LT-R <input type="checkbox"/>	▼

SCANNING TO MEMORY	
JOB NUMBER	:XXX
SCANNING PAGE	:YYY
RESIDUAL MEMORY	:ZZZ%

After scanning

BUILD FAX JOB	
1. SCAN NEXT ORIGINAL	▲
2. CHANGE CURRENT SETTING	
3. COMPLETE	▼

6 Select Build job Item.

- If there are no other sheets to scan, press (3).
→ Start the transmission.
- If you want to leave the scanning conditions unchanged, press (1).
→ After scanning the next sheet, return to this step.
- If you want to change the scanning conditions, press (2).
→ Go to step 7.

7 Set the items to change.

- To change resolution, press (2).
(▶ See page 2-10.)
- To change image density, press (3).
(▶ See page 2-12.)
- To change original size, press (4).
(▶ See step 5.)
- When you have finished setting the items, press (1).

BUILD FAX JOB
1. SCAN NEXT ORIGINAL
2. CHANGE CURRENT SETTING
3. COMPLETE

SCANNING TO MEMORY
JOB NUMBER : XXX
SCANNING PAGE : YYY
RESIDUAL MEMORY : ZZZ%

After scanning

BUILD FAX JOB
1. SCAN NEXT ORIGINAL
2. CHANGE CURRENT SETTING
3. COMPLETE

8 Scanning the Next Sheet.

- To scan the next sheet, press (1).
→ After scanning the sheet, return to step 6.

- After scanning all sheets, to select "3.COMplete" press (3).
→ Start the transmission.

7. SPECIFYING THE REMOTE FAX

2



- There are three ways of specifying the remote FAX: by the digital keys and by the SPEED DIAL key, and One Touch keys.
You can also specify remote FAXes by group using the SPEED DIAL key.
- The SPEED DIAL function is handy if you enter frequently called remote FAXes beforehand. (▶ See page 2-18.)
The group feature is handy if you want to send the same original to two or more remote FAXes in a single operation. (▶ See page 2-20.)
- Keypad: Press these keys to enter the remote FAX number.
- SPEED DIAL: Select an abbreviated number that is entered in the TEL LIST to specify the remote FAX.
The number of the remote FAX must already be entered to the TEL LIST. (▶ See page 4-8.)
- One Touch: Press a key that is already entered in the TEL LIST. (▶ See page 4-10.)
You can search for remote FAXes by spelling.
- Group: Enter the group number that is already entered as a group. This way you can specify two or more remote FAXes merely by specifying a single group. The numbers of the remote FAXes in the group must already be entered to the group. (▶ See page 4-12.)
You can search for groups by spelling.
- REDIAL key: Jobs (max. 100 telephone numbers), which are ready to be resent in the transmission memory appear on the message display panel. you can refax each by selecting a telephone number.

Keypad Dialing

1 Press the  key.

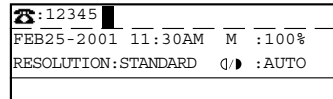
2 Enter the remote FAX number using the digital keys on the control panel.



3 If you make a mistake, press the  key on the control panel or the  key on the function keyboard and correct the mistake.

 key:

Pressing this key clears all of the values that you entered.

 key:

Each press of this key deletes the values that you are entering one by one.

 key

Pressing this key after highlighting the value with the  key deletes the value.

 key

Pressing this key permits the insertion of a desired character before (in front of) an existing character highlighted by the cursor. Press this key again to exit the Insert mode.

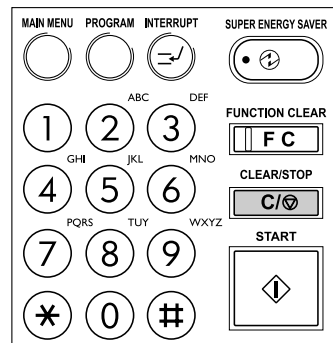

Pause Key

When you are dialing to an outside line via a PBX, it may take a moment or two to be connected after dialing an access digit (e.g. "9").

In this case, press the  key to enter a pause after the "9". This enters a pause before the remainder of the number is dialed.

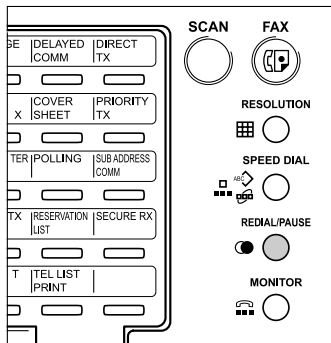

Tone Key

This key is used to send a tone signal, for example, to access information services such as fax on-demand system, voice menus, etc.

If you are using dial pulse (DP) dialing, the last number entered after pressing the  key becomes a tone signal.

For details on how to receive information services, contact the service provider.

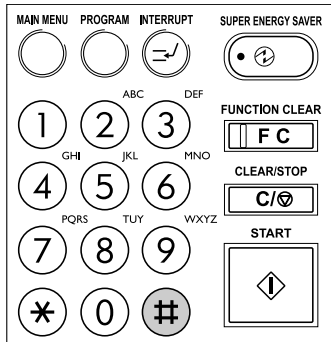

7. SPECIFYING THE REMOTE FAX (Cont.)

Abbreviated Dialing

1 Press the  key.

2 Select the Abbreviated Dialing.

Press :  then 

TELEPHONE NUMBERS LIST	___	___	___
ABB. NUMBER (1-999):	___	___	___

3 Enter the Abbreviated Dial Number (1 to 999) assigned to the desired remote FAX.

TELEPHONE NUMBERS LIST	___	___	___
ABB. NUMBER (1-999):	___	___	___

10

4 Press the  (or ) key.

- For scanning on the glass, setting the original size is required here. (e-STUDIO16 only. ► See page 2-14.)

TELEPHONE NUMBERS LIST	___	___	___
ABB. NUMBER:	___	___	010
LONDON OFFICE	___	___	___

Tip

Destinations must already have been entered.
(► See page 4-8.)

SCANNING TO MEMORY	___	___	___
JOB NUMBER	:	XXX	___
SCANNING PAGE	:	YYY	___
RESIDUAL MEMORY	:	ZZZ%	___

Alphabet Dialing

1 Press the  key.

2 Select the Alphabet Dialing.

Press :  then **2**

SEARCH NAME
ID NAME (MAX20) : _____
█

3 Enter the search characters using the keyboard on the Flip Panel and press the  key.



- Only names beginning with the search character are presented. The names that have the search character in the middle are not presented.
- Searching can be done irrespective of upper or lower case characters.

SEARCH NAME
ID NAME (MAX20) : _____
L

4 The relevant remote FAX names are displayed.

Select the destination using the  or  key.

SEARCH NAME
L.A OFFICE
LISBON OFFICE
LONDON OFFICE

5 Press the  (or ) key.

- For scanning on the glass, setting the original size is required here. (e-STUDIO16 only. ► See page 2-14.)

SCANNING TO MEMORY
JOB NUMBER : XXX
SCANNING PAGE : YYY
RESIDUAL MEMORY : ZZZ%

7. SPECIFYING THE REMOTE FAX (Cont.)

Group Dialing

1 Press the  key.

2 Select the Group Dialing.

Press :  then **3**

TELEPHONE NUMBERS LIST
GROUP NUMBER(1-1999):

3 Enter the Group Number (1 to 1999) assigned to the desired remote FAX group.

TELEPHONE NUMBERS LIST
GROUP NUMBER(1-1999):
0530

4 Press the  (or ) key.

- For scanning on the glass, setting the original size is required here. (e-STUDIO16 only. ► See page 2-14.)

TELEPHONE NUMBERS LIST
GROUP NUMBER: 0530
LONDON OFFICE



Tip

- You can see the registered groups in the list. (► See page 4-82.)
- Remote FAXes must be registered to the group beforehand. (► See page 4-12.)

SCANNING TO MEMORY
JOB NUMBER : XXX
SCANNING PAGE : YYY
RESIDUAL MEMORY : ZZZ%

One Touch Dialing

1 Press the  key.

- 2** Press the desired One Touch ( to ) key.
- The One Touch key number and the name of remote party appears on the message display about 2 seconds, and then sending start automatically.
 - For reading the original on the glass, setting the original size is required here. (e-STUDIO16 only. ► See page 2-14.)

Tip

Destinations must already have been entered.
(► See page 4-10.)

ONE TOUCH NUMBER	_____
ONE TOUCH:	_____ 01
LONDON OFFICE	

SCANNING TO MEMORY	_____
JOB NUMBER	: XXX
SCANNING PAGE	: YYY
RESIDUAL MEMORY	: ZZZ%

Dialing by REDIAL/PAUSE Key

1 Press the  key.

- 2** Press the  key.
- The jobs waiting to be redialed are displayed.

3 Using the  or  key, select the desired destination.

REDIAL	_____
1. CHICAGO OFFICE	_____ ▲
2. L.A. OFFICE	_____
3. LONDON OFFICE	_____ ▼

4 Press the  key.

8. SENDING ORIGINALS (MEMORY TX)

2

- There are two transmission modes: memory TX and direct TX.
- The factory default setting is memory TX.
- In memory TX, the original is scanned and temporarily stored to memory, and then sent. There are two ways for transmitting the original; one way is to transmit the original after storing a certain amount of data in memory (standard setting), and the other way is to transmit originals after scanning all of them. (► See pages 4-34 and 4-35.)
- Originals are scanned at high speed and stored to memory. So, you can return originals to their files immediately.
- You can specify two or more remote FAXes at once. (multi-address transmission)
- If the original cannot be sent because the remote FAX is busy, the remote FAX is automatically redialed. Default values for the redial intervals and the redial count vary from country to country. For setting values, refer to the Function List.
- Memory TX is no longer possible when the remaining memory reaches 0 %. If this happens, send in the direct TX mode. (► See pages 2-24 to 2-27.)
- Information can no longer be stored to memory if memory becomes full midway during scanning. Reduce the number of originals you are sending, or wait for remaining memory to increase, or try sending in the direct TX mode.
- Operation methods differ when the originals are placed on the original feed tray of the optional ADF or RADF and when they are placed on the original glass. For details on operations when the original is placed on the original glass, see “Setting the Scanning Conditions For Each Page.” (► See page 2-14.)

Memory TX

- Make sure that memory TX is set as the transmission mode in the PROGRAM menu. (▶ See page 4-26.)
- The factory setting is memory TX.

2

1 Press the  key.

2 Place the original.
• For details on how to place originals on the original glass.
(▶ See page 2-8.)

3 Set the scanning conditions. (▶ See pages 2-10 to 2-15.)

4 Dial the remote FAX number. (▶ See pages 2-16 to 2-21.)

- Abbreviated Dialing ▶ See page 2-18.
- Alphabet Dialing ▶ See page 2-19.
- Group Dialing ▶ See page 2-20.
- One Touch Dialing ▶ See page 2-21.

5 Press the  key.
The original starts to be scanned and is stored to memory.

Tip

- Transmitted-records are automatically printed out if any job fails to transmit (default "On Error").
- Canceling Transmission (▶ See page 2-31.)

9. SENDING ORIGINALS (DIRECT TX)

2

- When you have placed the originals and performed the sending operation, the remote FAX is immediately dialed, and originals are sent after connecting with the remote FAX with each page scanned separately.
- You can check immediately if the original has been sent to the remote FAX.
- Once scanned, originals are not stored in the memory.
- Operation methods are different depending upon whether the originals are placed on the original feed tray or they are placed on the original glass.
- After a page has been sent, the next page is scanned. This may increase the amount of time required to scan all pages.

Direct TX by Default Setting

- Make sure that direct TX is set as the transmission mode in the PROGRAM menu. (▶ See page 4-26.)
- The factory setting is memory TX.
- In the direct TX mode, you cannot specify two or more remote FAXes at one time.

Tip

- When direct TX is set using the transmission mode settings in the PROGRAM menu, all subsequent transmissions are in the direct TX mode.

1 Press the  key.

2 Place the original.

- For details on how to place the originals on the original glass. (▶ See page 2-8.)

3 Set the scanning conditions. (▶ See pages 2-10 to 2-15.)

4 Dial the remote FAX number. (▶ See pages 2-16 to 2-21.)

- A group cannot be designated as a remote FAX number.
- If the remote FAX is busy, the Message Display shown to the right is displayed.
- If the transmission fails, the Message Display shown to the right is displayed and the job is cancelled.
- Once connected to the remote FAX, the Message Display shown to the right is displayed.

```
DIALING
JOB NUMBER      : XXX
12345
```

```
Line busy
FEB25-2001 11:30AM M :100%
RESOLUTION:STANDARD 0/1 :AUTO
COMM.OPTION ▼
```

```
Communication error
FEB25-2001 11:30AM M :100%
RESOLUTION:STANDARD 0/1 :AUTO
COMM.OPTION ▼
```

```
TRANSMIT P001
JOB NUMBER      : XXX
EC SUPER G3
12345
```

Temporary Direct TX

- Even if the Memory TX Mode is selected as the Default, you may desire to transmit a specific original(s) in the Direct TX Mode.
- This feature is useful when the document consists of many pages or the when the residual memory is too small.

1 Press the  key.

2 Place the original.



- For details on how to place the originals on the original glass. (▶ See page 2-8.)

3 Set the Scanning conditions. (▶ See pages 2-10 to 2-15.)

4 Press the  key.

DIRECT TRANSMIT
1 . YES
2 . NO

5 Select the desired Direct TX Option.

- To select "1.YES", press  key.
- To select "1.NO", press  key.
- To cancel setting midway, press the  key.

ENTER TEL NUMBER (MAX128) :
FEB25-2001 11:30AM M :100%
RESOLUTION:STANDARD  :AUTO
COMM.OPTION ▼

6 Dial the remote FAX number. (▶ See pages 2-16 to 2-21.)

- The remote FAX is dialed immediately, and communications is started.
- A group cannot be designated as a remote FAX number.

DIALING
JOB NUMBER _____ : XXX
12345

COMMUNICATING
JOB NUMBER _____ : XXX
12345

9. SENDING ORIGINALS (DIRECT TX) (Cont.)

On-hook Transmission

- Originals are sent in the direct TX mode regardless of the memory TX/direct TX setting in the transmission mode setting.
In this mode, you can confirm the answering tone from the remote FAX.

2

1 Press the  key.

2 Place the original.

- For details on how to place originals on the original glass.
(▶ See page 2-8.)
- Only one original sheet can be sent when scanning original on the glass.

3 Set the scanning conditions. (▶ See pages 2-10 to 2-15.)



4 Press the  key in the Control Panel.

- You can hear the monitor tone from the built-in speaker.
- To cancel setting midway, press the  key again.

5 Dial the remote FAX number. (▶ See pages 2-16 to 2-21.)

- You can specify only one destination.

Note



In case of Keypad Dialing, each press of a digital key dials a number. So, if you make a mistake when dialing the remote FAX number, press the  key to cut the line, press the  key again and redial.



6 When you hear the answering tone output from the built-in speaker after the connection is made with the remote FAX, press the  key.

7 Press the  key. (Select “1.TRANSMIT”).

- For scanning on the glass, setting the original size is required here. (e-STUDIO16 only. ▶ See page 2-14.)

DIAL TEL NUMBER:
FEB25-2001 11:30AM M :100%
RESOLUTION:STANDARD  :AUTO

 110
FEB25-2001 11:30AM M :100%
RESOLUTION:STANDARD  :AUTO

COMMUNICATING SETTING
1. TRANSMIT 
2. RECEIVE 

COMMUNICATING
JOB NUMBER _____ :XXX
110

Off-hook Transmission (External Telephone Dialing)

Tips

- The optional external telephone is required.
- You can specify the remote FAX using only the external telephone.

2

1 Press the  key.

2 Place the original.

- For details on how to place originals on the original glass. (► See page 2-8.)
- Only one original sheet can be sent when scanning an original on the glass.

3 Set the scanning conditions. (► See pages 2-10 to 2-15.)

4 Pick up the handset of the External Telephone.

External off hook
FEB25-2001 11:30AM M :100%
RESOLUTION:STANDARD (D) :AUTO

5 Enter the remote FAX number using the keypad of the External Telephone.

6 When you hear the answering tone output from the External Telephone after the connection is made with the remote FAX, press the  key.

COMMUNICATING SETTING
1. TRANSMIT ▲
2. RECEIVE ▼

7 Press the  key. (Select “1.TRANSMIT”.)

- For scanning on the glass, setting for the original size is required here. (e-STUDIO16 only. ► See page 2-14.)

COMMUNICATING
JOB NUMBER : XXX

8 When you hear the digital copier switch the phone line, replace the handset of the External Telephone.

TRANSMIT P001
JOB NUMBER : XXX
EC SUPER G3

10. CHECKING TRANSMISSION RESULTS

Checking Transmission Results on the Message Display



You can display the last 150 transmission on the LCD.
You can also print out a report of the displayed job.

2

1 Press the  key.

2 Press the  key.

123456	▲	
0987654321	▼	
PRINT	◀ ▶	DETAIL

3 Use  or  key to display the desired job,
and press  key to display the details.

0987654321		
OK P001		
JOB NO.:XXX FEB25 09:10AM		
PRINT	◀ ▶	RESUME

4 If you want to print a report of the displayed job,
press the  key.

ENTER TEL NUMBER(MAX128):
Printing list
RESOLUTION:STANDARD Q/D :AUTO
COMM.OPTION ▼

Checking Transmission Results by Printing Reports

- Print out the Transmission Journal to check the transmission results. The Transmission Journal is printed by the following operation as the default. You can set to print the Transmission Journal automatically as well. (▶ See page 4-53.)
- You can select either printing only the Transmission Report, printing only the Reception Report, or printing both the Transmission Report and Reception Report. Both the Transmission Report and Reception Report are printed as the default.
- In the Transmission Journal, you can check the following information relating to transmission in the memory TX and direct TX modes:
 - Serial number
 - Job number
 - Communications start date
 - Communications time (Minutes/Seconds)
 - Number of originals
 - Destination
 - Department Number
 - Account number
 - Communication mode
 - Result

1 Press the  key.

2 Press the  key.

PRINT NUMBER		
1.1-50	(1 PAGE)	▲
2.1-100	(2 PAGES)	
3.1-150	(3 PAGES)	▼

3 Select the Print Number.

- To print the 50 communications (1 page), press **1**.
- To print the 100 communications (2 pages), press **2**.
- To print the 150 communications (3 pages), press **3**.
- Transmission report print out. For details on how to read reports, see the "Transmission Journal."
(▶ See pages 4-61 and 4-62.)

ENTER TEL NUMBER (MAX128):	
Printing list	
RESOLUTION:STANDARD	Q/▶ :AUTO
	COMM.OPTION ▼

10. CHECKING TRANSMISSION RESULTS (Cont.)

Checking Reserved Transmissions by Printing Reports

Print out the Reservation List to check the reserved transmission job status.

In the Reservation List, you can check the following information relating to transmissions in the memory

TX mode:

- JOB NUMBER
- TYPE
- PAGES
- MAILBOX NUMBER
- DATE & TIME
- DESTINATION

2

1 Press the  key.

2 Press the  key.

- For details on how to read reports, see the "Reservation List." (▶ See page 4-77.)

ENTER TEL NUMBER (MAX128):
Printing list
RESOLUTION:STANDARD Q/D :AUTO
COMM.OPTION ▼

11. CANCELING TRANSMISSIONS

Canceling transmissions (during scanning)

- 1 Press the  key while the original is being scanned. Scanning (storing to memory) is cancelled.



Canceling Reserved Memory Transmissions Canceling Memory Transmissions (during transmission)

- Cancel reserved memory transmissions that are currently stored to memory and waiting to be sent.

- 1 Press the  key.

- 2 Press the  key.
 - The last three jobs are displayed on the Message Display.

901234567890	TRANSMIT	▲
650-845-1111	RESERVE	
LONDON OFFIC	RESERVE	▼
[CANCEL]		[◀] [▶] [DETAIL]



- 3 Select the desired job to be canceled by using the  or  key.

901234567890	TRANSMIT	▲
650-845-1111	RESERVE	
LONDON OFFIC	RESERVE	▼
[CANCEL]		[◀] [▶] [DETAIL]

- To confirm the job for details, press the  key.

SINGLE TRANSMIT		
650-845-1111		
JOB NO.:yyy	FEB25 09:10AM	
[CANCEL]		[◀] [▶] [RESUME]

- 4 Press the  key. The confirmation screen appears.

- To select "1.YES", press .
- To select "2.NO", press .

CANCEL THIS JOB? _ _ _ _	
650-485-1111	
1.YES	▲
2.NO	▼

- 5 Press the  key to return to the initial screen for FAX.

Job cancelled	
650-845-1111	

11. CANCELING TRANSMISSIONS (Cont.)

Canceling Direct Transmission

1 Press the  key during transmission (scanning).

2

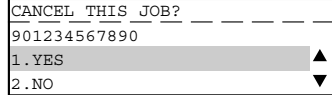
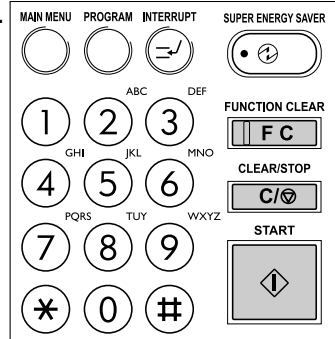

2 Select the desired option.



- To cancel the transmission, press **1**.
- To continue the transmission, press **2**.

Tip

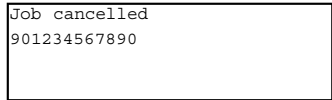
Even if you cancel a transmission in the direct TX mode, the original that was being sent before transmission was canceled is sent as it is to the remote FAX.



12. RECEPTION-TYPES OF AUTO RECEPTION MODE

	Mode	When to Set	Description
1.	AUTO RECEIVE	Set this mode when the line is being used exclusively by the FAX.	The FAX automatically receives incoming originals when the bell rings.
2.	MANUAL RECEIVE	Set this mode when the FAX is connected to a line that is also used as a voice telephone line.	<p>When the bell sounds, pick up the handset of the telephone. If the incoming call is a telephone call, start talking with the other party.</p> <p>If you hear a facsimile tone, press the  key and the  key. Select "2.RECEIVE" and replace the handset to the cradle after you hear the phone line switch. The original then starts to be received.</p> <p>Tip</p> <p>You cannot talk with the other party unless an external telephone is attached.</p>

2



Setting AUTO RECEIVE Modes

1 Display the AUTO RECEIVE Mode menu.

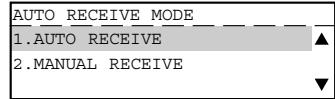
Press:  then      



2 Select the desired Receive Mode.

- To set the AUTO RECEIVE, press .
- To set the MANUAL RECEIVE, press .
- When "1.AUTO RECEIVE" is selected, follow step 3.
- When "2.MANUAL RECEIVE" is selected, the setting procedure is completed.
- To cancel setting midway, press the  key.

AUTO RECEIVE is selected:

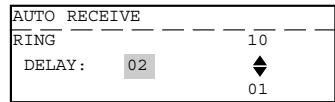

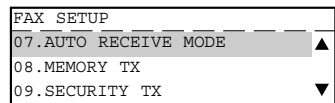

MANUAL RECEIVE is selected:



12. RECEPTION-TYPES OF AUTO RECEPTION MODE (Cont.)

3 Select the Ring Delay (number of rings before the FAX will answer the incoming calls.)

- Set the Ring Delay using the  or  key.
(Default is different for each country.)
- When the desired ring count is displayed on the LCD, press the  key.

4 Press the key to return to the initial screen for FAX.

2

13. MEMORY RX

- This digital copier stores the information of received originals in the memory to ensure communications even if some problem (e.g. a paper jam or no more paper in the digital copier) occurs during reception and prevents the originals from being printed.
- If an original is received, for example, when the digital copier is out of paper, the received original is automatically stored in memory. This function is called “memory RX.”
- Memory RX is carried out in the following instances:
 - During copying
 - During printing of received originals
 - During printing of lists and reports
 - When the digital copier has run out of paper
 - When the digital copier has run out of toner
 - During a paper jam
- The Memory RX is set to ON as the default.

Memory RX Setting

1 Display the Memory RX menu.

Press: ^{PROGRAM} then



2 Select the Memory Reception Option.

- To set the Memory Reception OFF, press .
- To set the Memory Reception ON, press .

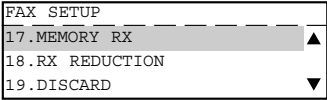

3 Press the ^{MAN MENU} key to return to the initial screen for FAX.

Outputting Originals Stored in the Memory

1 Eliminate the problem.

- When the problem is eliminated, the documents that are received to memory are automatically output.

14. USING THE TELEPHONE

On-hook Dialing

The external telephone is needed.

2



1 Press the  key.

2 Press the  key.

3 Dial the remote telephone number.
(▶ See pages 2-16 to 2-21.)

Note

Each press of a digital key dials a number.

So, if you make a mistake when dialing the remote FAX number, press the  key to cut the line, press the  key again and redial.

4 Pick up the handset of the attached external telephone.



5 Press the  key on the control panel and start talking.

Off-hook Dialing (External Telephone)

- 1 Press the  key.
- 2 Pick up the handset of an external telephone.
- 3 Enter the remote telephone number using the keypad of the External Telephone.
 - The dial number is not displayed on the Message Display when dialing from the External Telephone.



Sending a Tone

- Tone services can be used even on pulse dial lines.

- 1 Press the  key.
- 2 To receive a tone service, press the  key to switch over to tone transmission.
 - For details of services and how to receive information services, contact the service provider.

Tip

How to Receive FAX Information Services

1. Pick up the handset and specify the FAX information service number.
2. When the line is connected to the service, you will hear a pre-recorded announcement. Follow the instructions in the announcement, and enter numbers as necessary. When the telephone line is a dial pulse line, the service cannot be used as it is. So, press the  key before you enter the service codes to enable tone transmission.
3. Press the  key, check that the message "RECEIVE" is displayed before you press the  key and replace the handset.

ADVANCED FEATURES

1. DELAYED COMMUNICATION (TIME DESIGNATION)	3-3
2. PRIORITY TRANSMISSION (PRIORITY TX)	3-4
3. SENDING TWO-SIDED ORIGINALS	3-5
4. LOW SPEED TRANSMISSION	3-6
5. MULTI-ADDRESS TRANSMISSION (BROADCASTING)	3-7
Multi-Key Quick Broadcast	3-7
Group Broadcast Transmission	3-8
6. MAILBOX (ITU-T COMPATIBLE)	3-9
Setting Up an Open Mailbox	3-10
Deleting an Open Mailbox	3-11
Reserving a Document to a Mailbox (Local Hub)	3-12
Printing a Document from a Mailbox (Local Hub)	3-13
Sending a Document to a Mailbox (Remote Hub)	3-14
Retrieving (Polling) a Document from a Mailbox (Remote Hub)	3-15
Deleting Documents in a Mailbox (Local Hub)	3-16
Relay Transmission, Relay-Relay Transmission Overview	3-17
7. RELAY TRANSMISSION	3-17
Setting Up a Relay Box	3-19
Deleting a Relay Box	3-21
Relay Transmission to a Remote Hub	3-22
8. POLLING COMMUNICATIONS	3-23
Polling Reservation	3-23
Individual Polling RX	3-25
For details on how to specify remote FAXes using Multi-polling RX	3-26
Turnaround Polling	3-27
Continuous Polling	3-28
Clear the Settings of the Continuous Polling	3-30
9. CHAIN DIALING	3-31



3

1. DELAYED COMMUNICATION (TIME DESIGNATION)

- This function allows you to send originals to a remote FAX at a specified time and specified day. This function comes in handy when you want to make use of off-peak discounts (e.g. night-time) and make use of time differences when sending overseas. You can reserve a transmission up to one month in advance.
- You can set the time (hours/minutes) and the day (DD).



1 Press the  key.

2 Place the original.
• For details on how to place originals on the original glass.
(▶ See page 2-8.)

3 Set the scanning conditions. (▶ See pages 2-10 to 2-15.)



4 Press the  key (on the Function key panel).

DELAYED COMM.	
TIME	: HH : MM DD
	PM
	◀ ▶

5 Enter the time (hours/minutes) and day (DD) using the digital keys. Press the  or  key to move the cursor.

DELAYED COMM.	
TIME	: HH : MM DD
	08 : 10AM ◀ 15
	◀ ▶

6 Press the  key to complete settings.

- To cancel setting midway, press the  key.
- To correct the entered value, highlight the character using the  key and overwrite on it.
- The time function corresponds to the date and time setting within the Copier functions. (Refer to the Operator's Manual (For Copying Functions).)
- Select "AM" or "PM" when the time is displayed in the 12-hour format.

7 Specify the remote FAX, and press the  key.

SCANNING TO MEMORY	
JOB NUMBER	: XXX
SCANNING PAGE	: YYY
RESIDUAL MEMORY	: ZZZ%

2. PRIORITY TRANSMISSION (PRIORITY TX)

- Priority Transmission allows you to perform a transmission before any other reserved transmission job (including redial standby).
- Priority Transmission is good for single transmission only.
- Only one communication can be reserved as a Priority Transmission.

1 Press the  key.

2 Place the original.

- For details on how to place originals on the original glass. (▶ See page 2-8.)

3 Set the scanning conditions. (▶ See pages 2-10 to 2-15.)

4 Press the  key (on the Function key panel).

PRIORITY RESERVE
ENTER TEL NUMBER OR,
PRESS SPEED DIAL KEY
OR ONE TOUCH KEY

5 Specify the remote FAX number.

PRIORITY RESERVE
 :12345

3. SENDING TWO-SIDED ORIGINALS

- You can scan and send two-sided originals using the reversing document feeder. (Optional RADF is required.)
- This function setting is valid for the current job (one transmission) only.

1 Press the  key.

2 Place the original.
• For details on how to place originals on the original glass.
(▶ See page 2-8.)



3 Set the scanning conditions. (▶ See pages 2-10 to 2-15.)
• Make sure that MEMORY TX has been set in the FAX SETUP.

4 Press the  key to display the COMM. OPTION menu with the initial screen of the FAX Mode.

1. SECURITY TX	: OFF	▲
2. ECM	: ON	
3. LONG ORIGINAL	: OFF	
4. LINE MONITOR	: OFF	▼

5 To select “6. DUPLEX SENDING”, press .

DUPLEX SENDING		
1. OFF		▲
2. ON		▼

6 To select “2. ON”, press .
• To cancel setting midway, press the  key.

7 Specify the remote FAX, and press the  key.

4. LOW SPEED TRANSMISSION

If communication errors frequently occur while transmitting documents due to bad phone lines, we recommend you to select a lower transmission speed to enable quality transmissions.

- The transmission speed will be restored to the default value automatically after the low speed transmission is completed.

1 Press the  key.

2 Press the  key (on the Function key panel) and resend the original.

Note

LOW SPEED TX takes longer than regular transmission as the documents are sent at a slower bit rate.

3 Select the desired bit rate.

- To select OFF, press **1**.
- To select 14400 BPS, press **2**.
- To select 9600 BPS, press **3**.
- To select 4800 BPS, press **4**.

QUALITY TX	
1. OFF	▲
2. 14400 BPS	
3. 9600 BPS	▼



QUALITY TX	
2. 14400 BPS	▲
3. 9600 BPS	
4. 4800 BPS	▼

4 Specifying the remote FAX and press the  key. (▶ See pages 2-16 to 2-21.)

5. MULTI-ADDRESS TRANSMISSION (BROADCASTING)

- The “multi-address transmission” function allows you to send the same original to two or more remote FAXes in a single operation. This eliminates the trouble of placing the original in the copier and then dialing the number for each destination. You can set multi-address transmission only in the memory TX mode. There are two different types of multi-address transmissions: Multi-key Quick Broadcast transmission and Group Broadcast transmission.
- Multi-key Quick Broadcast transmission: This is a means of specifying multiple remote FAXes using the Speed Dial, One Touch key, and digital keys whenever you want to send an original. Up to 475 destinations can be assigned to an Individual multi-address transmission. Up to 100 destinations can be assigned when the destinations are assigned using only the Digital keys.
- Group Broadcast transmission: This is a means of pre-entering remote FAXes that you often send the same original to as a group, and specifying this group when you want to send an original. For details on how to program groups, see “Group Number Registration.” (▶ See page 4-12.) The allowable number of destinations per group is as follows:
 - Maximum number of destinations per group: 375
 - Maximum number of groups: 50

Multi-Key Quick Broadcast

- 1** Press the  key.
- 2** Place the original.
 - For details on how to place originals on the original glass. (▶ See page 2-8.)
- 3** Set the scanning conditions. (▶ See pages 2-10 to 2-15.)
- 4** Press the  key (on the Function key panel).

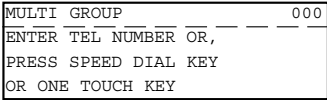

- 5** Enter the remote FAX number.
 - Abbreviated Dialing ▶ See page 2-18
 - Alphabet Dialing ▶ See page 2-19
 - One Touch Dialing ▶ See page 2-21
 - Keypad Dialing ▶ See page 2-16
 - Repeat this step until the facsimile numbers of all the desired remote parties are enter.
 - When the facsimile numbers of all the desired remote parties are entered, go to step 7.
 - To delete or modify a facsimile number already programmed to a Manual Group Dial, go to step 6.

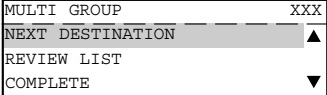
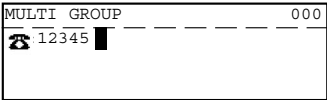



5. MULTI-ADDRESS TRANSMISSION (BROADCASTING) (Cont.)

6 Select the DELETE or MODIFY Facsimile Number.

- Select "REVIEW LIST" and Press  key.

001.0333801234	▲
002.LONDON OFFICE	
003.CHICAGO OFFICE	▼
<input type="button" value="DELETE"/> ◀ ▶ <input type="button" value="MODIFY"/>	

a. Delete the Existing Number.



- Use the  or  key to select the desired number and press the  key.

DELETE?	_____
0333801234	
1.YES	▲
2.NO	▼

- Select "1.YES" and press the  key.

MULTI GROUP	_____	000
0333801234		
Deleted		

b. Modify the Existing Number.

- Use the  or  key to select the desired number and press the  key.

MULTI GROUP	_____	000
	0333801234	

- Enter correct number and press the  key.

001.0333805678	▲
002.LONDON OFFICE	
003.CHICAGO OFFICE	▼
<input type="button" value="DELETE"/> ◀ ▶ <input type="button" value="MODIFY"/>	

7 Specify all remote FAXes, and then press the or select "COMPLETE" and press key.

Group Broadcast Transmission

- You can send originals to two or more remote FAXes that have been preset as a group. For details on how to program groups. (▶ See page 4-12.)

1 Press the key.

2 Place the original.

- For details on how to place originals on the original glass. (▶ See page 2-8.)

3 Set the scanning conditions. (▶ See pages 2-10 to 2-15.)

4 Specify the remote FAX.

- Group Dialing (▶ See page 2-20.)

GROUP NUMBER	_____	0001
ONE TOUCH:	_____	02
LONDON OFFICE		

6. MAILBOX (ITU-T COMPATIBLE)

Open Mailbox allows storage and retrieval of documents via mailboxes that are already set up in a mailbox hub.

The following two types of Open Mailboxes are available:

- **Confidential Box:** Confidential Box allows one-time document retrieval from the mailbox. Once a document is retrieved, it is cleared. If a new document is stored using the same box number where another document is present, it is added to the existing one. It is also possible to set up a password requirement for accessing the Confidential Box for document retrieval to prevent unauthorized retrieval of the documents. This password is required if the documents are to be retrieved by a remote facsimile.
- **Bulletin Board Box:** Bulletin Board Box allows multiple document retrievals from the mailbox. Once a document is retrieved, it is not cleared. If a new document is stored using the same Box number where another is present, it replaces the existing one. It is also possible to set up a password requirement for accessing the Bulletin Board Box for document reservation (no password is necessary for document retrieval).

Open Mailbox conditions

Sending and storage of documents to a mailbox hub and retrieval of documents from a mailbox hub is possible only with an ITU-T compliant facsimile.

Only ITU-T compliant facsimiles can be used as Open Mailbox hubs. This digital copier is provided with mailbox hub functions.

- Preparation involves setting up an Open Mailbox for storing documents within the mailbox hub.

6. MAILBOX (ITU-T COMPATIBLE) (Cont.)

Setting Up an Open Mailbox

In order to carry out ITU-T communications, you must first set up an Open Mailbox in the mailbox hub. You can set up a maximum of 100 Confidential and Bulletin Board boxes.

1 Press the  key.

2 Press the  key (on the Function key panel).

MAILBOX	
1. CONFIDENTIAL	▲
2. BULLETIN BOARD	
3. RELAY	▼



3 To select "4. MAILBOX SETUP", press .

MAILBOX SETUP	
1. COMPLETE	▲
2. MAILBOX SETUP	
3. MAILBOX DELETE	▼

4 To select "2. MAILBOX SETUP", press .

MAILBOX TYPE	
1. CONFIDENTIAL	▲
2. BULLETIN BOARD	
3. RELAY	▼

5 Select the Mailbox Type.

- To select "Confidential", press .
- To select "Bulletin Board", press .

MAILBOX SETUP (CONFIDENTIAL)	
NEW MAILBOX NUMBER (MAX20) :	
█	

6 Enter the mailbox number.

MAILBOX SETUP (CONFIDENTIAL)	
PROGRAM PASSWORD?	
1. YES	▲
2. NO	▼

7 Select the password option.

- If you selected the Confidential Box in Step 5, a password must be used if the document is to be retrieved remotely. The remote facsimile will require its operator to enter this password before being able to retrieve the document.
- If you selected the Bulletin Board Box in Step 5, assigning a password will require a password to be entered before any documents can be reserved into the Bulletin Board Box.

MAILBOX SETUP (CONFIDENTIAL)	
PASSWORD (MAX20) :	
█	

8 Enter the password.

- The password indicated with *'s.
- The setup is completed and the display returns to the screen in Step 4.

MAILBOX SETUP	
1. CONFIDENTIAL	▲
2. MAILBOX SETUP	
3. MAILBOX DELETE	▼

Deleting an Open Mailbox

This section describes the procedures to delete an exiting Open Mailbox within the hub unit.

Note

If a document exists in the Open Mailbox that you want to delete, this operation is not allowed until the document is retrieved, printed, or canceled from the Open Mailbox.

3

1 Press the  key.

2 Select the MAILBOX SETUP.

Press:  then 

MAILBOX SETUP
1. COMPLETE
2. MAILBOX SETUP
3. MAILBOX DELETE

3 To select "3. MAILBOX DELETE", press .

DELETE MAILBOX NUMBER
MAILBOX NUMBER (MAX20) :
█

4 Enter the mailbox number and press the  key.

DELETE MAILBOX NUMBER
MAILBOX NUMBER (MAX20) :
500 █

5 Enter the password and press the  key.

- Make sure that the correct password is entered. Otherwise, the Message Display shows "Invalid number".
- When deletion is accepted, the message as shown right is displayed and the display returns to the screen in Step 2.

DELETE MAILBOX NUMBER
PASSWORD (MAX20) :
**** █

DELETE MAILBOX NUMBER
Deleted

6. MAILBOX (ITU-T COMPATIBLE) (Cont.)

Reserving a Document to a Mailbox (Local Hub)

This section describes the procedure to reserve a document to a mailbox (Confidential Box or Bulletin Board) within a local hub.

1 Press the  key.

2 Place the original.

- For details on how to place originals on the original glass. (▶ See page 2-8.)

3 Set the scanning conditions. (▶ See pages 2-10 to 2-15.)

4 Display the MAILBOX Menu and select the Mailbox Type.

Press:  then **1** or **2**

- To reserve the document to a Confidential Box, press **1**.
- To reserve the document to a Bulletin Board, press **2**.

5 To select "4.INPUT TO MAIL BOX," press **4**.

CONFIDENTIAL
1.PRINT MAILBOX ▲
2.TX TO MAILBOX
3.POLL FROM MAILBOX ▼

6 Enter the box number and press the  key.

INPUT (CONFIDENTIAL)
MAILBOX NUMBER (MAX20) :

SCANNING TO MEMORY	_____
JOB NUMBER	: XXX
SCANNING PAGE	: YYY
RESIDUAL MEMORY	: ZZZ%

- When the entered box number does not exist, the message as shown to the right is displayed. After 2 seconds, the display returns to the screen for entering the box number.
- When Bulletin Board Box is selected in Step 4, the screen for entering the password is displayed.

INPUT (CONFIDENTIAL)

No entry

Printing a Document from a Mailbox (Local Hub)

This section describes the procedure for printing (retrieving) a document from a mailbox (Confidential or Bulletin Board) in a local hub.

1 Press the  key.

2 Display the MAILBOX Menu and select the Mailbox Type.

Press:  then **1** or **2**

- To print a document within a Confidential Box, press **1**.
- To print a document within a Bulletin Board, press **2**.

3 To select "1. PRINT MAILBOX," press **1**.

```
CONFIDENTIAL
1. PRINT MAILBOX
2. TX TO MAILBOX
3. POLL FROM MAILBOX
```

4 Enter the box number and press the  key.

- When the entered box number does not exist, the message shown to the right is displayed. After 2 seconds, the display returns to the screen for entering the box number.

```
PRINT (CONFIDENTIAL)
MAILBOX NUMBER (MAX20) :
```

```
PRINT (CONFIDENTIAL)
PASSWORD (MAX20) :
```

```
PRINT (CONFIDENTIAL)
No entry
```

5 Enter the password and press the  key.

- The facsimile starts printing the document.
- When the password is incorrect, the message shown to the right is displayed. After 2 seconds, the display returns to the screen for entering the password.

```
ENTER TEL NUMBER (MAX128) :
Printing list
RESOLUTION:STANDARD 0/1 :AUTO
COMM.OPTION ▼
```

```
PRINT (CONFIDENTIAL)
Invalid number
```

6. MAILBOX (ITU-T COMPATIBLE) (Cont.)

Sending a Document to a Mailbox (Remote Hub)

This section describes the procedures to send a document to a remote hub unit's Confidential Box, or reserving a document to a Bulletin Board Box in a remote hub unit.

- The remote hub unit must be compliant with ITU-T F-code communications.

Note

The destination mailbox number must be setup in the remote hub unit prior to sending document.

3

1 Press the  key.

2 Place the original.

- For details on how to place the originals on the original glass.
(▶ See page 2-8.)

3 Set the scanning conditions. (▶ See pages 2-10 to 2-15.)

4 Display the MAILBOX Menu and select the Mailbox Type.

Press:  then **1** or **2**

- To send the document to a Confidential Box, press **1**.
- To reserve the document to a Bulletin Board, press **2**.

5 To select "2.TX TO MAILBOX," press **2**.

CONFIDENTIAL
1.PRINT MAILBOX ▲
2.TX TO MAILBOX
3.POLL FROM MAILBOX ▼

6 Enter the box number and press the  key.

- When the entered box number does not exist, the message shown to the right is displayed. After 2 seconds, the display returns to the screen for entering the box number.
- When Bulletin Board Box is selected in Step 4, the screen for entering the password is displayed.

TX (CONFIDENTIAL)
MAILBOX NUMBER (MAX20) :

TX (CONFIDENTIAL)
ENTER TEL NUMBER OR,
PRESS SPEED DIAL KEY
OR ONE TOUCH KEY

TX (CONFIDENTIAL)
No entry

7 Dial the FAX number of the remote hub unit.

TX (CONFIDENTIAL)
ONE TOUCH : 01
REDFIELD H.S.

Retrieving (Polling) a Document from a Mailbox (Remote Hub)

This section describes the procedure to retrieve a document from a MAILBOX (Confidential Box or Bulletin Board) located in a remote hub.

1 Press the  key.

2 Display the MAILBOX Menu and select the Mailbox Type.

Press:  then **1** or **2**

```
CONFIDENTIAL
-----
1.PRINT MAILBOX
2.TX TO MAILBOX
3.POLL FROM MAILBOX
```

3 To select "3. POLL FROM MAILBOX," press **3**.

```
POLL (CONFIDENTIAL)
MAILBOX NUMBER (MAX20) :
█
```

4 Enter the box number and press the  key.

```
POLL (CONFIDENTIAL)
PASSWORD = (MAX20)
█
```

- When the entered box number does not exist, the message shown to the right is displayed. After 2 seconds, the display returns to the screen for entering the box number.

```
POLL (CONFIDENTIAL)
-----
No entry
```

5 Enter the password to access the Confidential Box and press the  key.

```
POLL (CONFIDENTIAL)
ENTER TEL NUMBER OR,
PRESS SPEED DIAL KEY
OR ONE TOUCH KEY
```

- When the password is incorrect, the message shown to the right is displayed. After 2 seconds, the display returns to the screen for entering the password.

```
POLL (CONFIDENTIAL)
-----
Invalid for number
```

6 Dial the FAX number of the Remote Hub Unit.

- The facsimile starts dialing to the remote hub unit to retrieve the document.

```
POLL (CONFIDENTIAL)
ONE TOUCH : 01
REDFIELD H.S.
```

6. MAILBOX (ITU-T COMPATIBLE) (Cont.)

Deleting Documents in a Mailbox (Local Hub)

This section describes the procedure to delete the documents stored in the local hub. (Confidential Box or Bulletin Board)

- This operation will erase all existing documents in each mailbox, but not erase the mailbox itself.

3

1 Press the  key.

2 Display the MAILBOX Menu and select the Mailbox Type.

Press:  then **1** or **2**

CANCEL (CONFIDENTIAL)
1.PRINT MAILBOX ▲
2.TX TO MAILBOX
3.POLL FROM MAILBOX ▼

3 To select "5. CANCEL MAILBOX," press **5**.

CANCEL (CONFIDENTIAL)
MAILBOX NUMBER (MAX20):

4 Enter the box number to be deleted its contents and press the  key.

CANCEL (CONFIDENTIAL)
PASSWORD (MAX20):

- When the entered box number does not exist, the message shown to the right is displayed. After 2 seconds, the display returns to the screen for entering the box number.

CANCEL (CONFIDENTIAL)
No entry

5 Enter the password to access the Confidential Box and press the  key.

CANCEL (CONFIDENTIAL)
Cancelled

- The facsimile will display the "cancelled" response (as shown) for approximately 2 seconds before returning to the Standby Mode.
- When the password is incorrect, the message shown to the right is displayed. After 2 seconds, the display returns to the screen for entering the password.

CANCEL (CONFIDENTIAL)
Invalid number

7. RELAY TRANSMISSION

Relay Transmission, Relay-Relay Transmission Overview

◆ What is a “Relay Transmission”?

A relay transmission is used to send documents from your facsimile (originator) to a Hub Station, which then sends them to additional end stations. If you have several stations in one or more regional areas (e.g. Los Angeles Metro, New York City, Dallas-Ft. Worth, Seattle-Tacoma, etc.); you can save time and phone charges by setting up a relay system. By sending your document to a Hub Station, you can then instruct the Hub Station to retransmit the document to the end stations in their local geographical area.

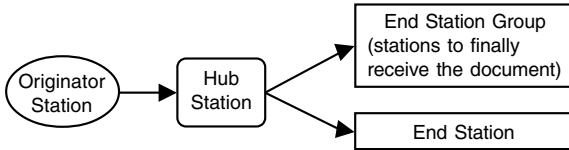

◆ What is a “Relay-Relay Transmission”?

A Relay Transmission where two levels of Hub Stations are involved is called a Relay-Relay Transmission. In a Relay-Relay Transmission, the first Hub Station sends the document to another Hub Station(s) which then transmits them to additional end stations.

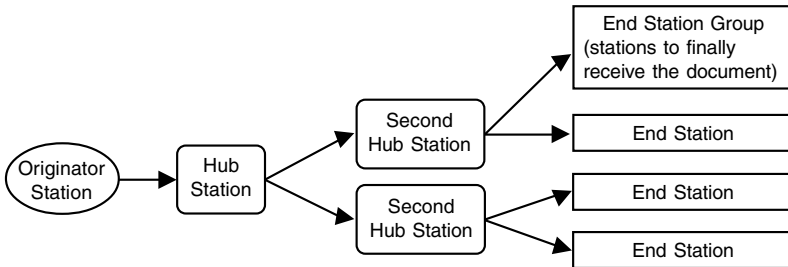

7. RELAY TRANSMISSION (Cont.)

To perform Relay Transmissions or Relay-Relay Transmissions, you must build a network beforehand. Consult your authorized TOSHIBA dealer for assistance in using this function.

● Conditions for a Relay/Relay-Relay Transmission Network

1. The sending station must be a this machine or another ITU-T relay communication compatible facsimile unit.
2. The Hub Station must be a this machine facsimile or another ITU-T relay communication compatible facsimile unit with the Hub Station functions.
3. The relay station must program the end station telephone numbers to Abbreviated Dial numbers or One Touch keys or Group numbers. Up to 50 abbreviated dial numbers or one touch keys or groups can be programmed. For information on setting Relay Box. (▶ See page 3-19.)
4. Due to advanced planning and setup requirements for the Relay-Relay transmissions involving two or more Hub Stations transfers, contact your authorized TOSHIBA dealer for detailed instructions.

● How to Setup a Relay Transmission:

- Hub Station
Create a Relay Box within a hub unit (like this machine) by following the procedures beginning on page 3-19.

Note

A Relay Box must be established for every possible unit if you wish to obtain a result report after the relay is completed.

- Originator
Transmit a document to the hub unit from an ITU-T relay compatible remote facsimile (like this machine) with the procedures beginning on page 3-22.
- ### ● How to Setup a Relay-Relay Transmission:
- Hub Station
 1. Register the facsimile telephone number of the Second Hub Station to a One Touch key or Abbreviated Number, see pages 2-18 and 2-21 At this time, the Relay Box Number located in the Second Hub Station should be registered as the SUB Address of the One Touch key or Abbreviated Number.
 2. Create a Relay Box in the Hub Station, see "Setting Up a Relay Box." Register the One Touch key or Abbreviated Number programmed in Step 1 to the Relay Box as the Second Hub Station.
 - Second Hub Station
 1. Register the facsimile telephone number of the End Station to a One Touch key or Abbreviated Number. (▶ See pages 2-18 and 2-21.)
 2. Create a Relay Box in the Second Hub Station, see "Setting Up a Relay Box." Register the One Touch key or Abbreviated Number programmed in Step 1 to the Relay Box as the End Station.
 - Originator
Transmit a document to the hub unit from an ITU-T relay compatible remote facsimile (like this machine) with the procedures beginning on page 3-22.

Setting Up a Relay Box

This section describes the procedure to setup a Relay Box in the hub unit. Using this function, all ITU-T F-code compliant facsimiles can be received or transmit documents to and from this machine. You can assign a maximum of 50 End Stations using Abbreviated Dial Numbers, One Touch keys, or Group Numbers.

1 Press the  key.

2 Displaying the MAILBOX Menu and select BOX SETUP.

Press:  then **4**

```
MAILBOX SETUP
1. COMPLETE
2. MAILBOX SETUP
3. MAILBOX DELETE
```

3 To select "2. MAILBOX SETUP," press **2**.

```
MAILBOX TYPE
1. CONFIDENTIAL
2. BULLETIN BOARD
3. RELAY
```

4 To select "3. RELAY," press **3**.

```
MAILBOX SETUP (RELAY)
NEW MAILBOX NUMBER (MAX20) :
```

5 Enter the Relay Box number and press  key.

```
MAILBOX SETUP (RELAY)
PROGRAM PASSWORD?
1. YES
2. NO
```

6 Select the password option.

• To set password option for this relay box, press **1**.
Go to Step 7.

• If you do not wish this relay box, press **2**. Go to Step 8.

```
MAILBOX SETUP (RELAY)
PASSWORD (MAX20) :
```

7 Enter the password.

```
RELAY END NUMBER
PRESS SPEED DIAL KEY
OR ONE TOUCH KEY
```

7. RELAY TRANSMISSION (Cont.)

8 Enter the End Station.

- If the end station is assigned to a One Touch key, press designated One Touch key.

RELAY END NUMBER	_____
ONE TOUCH :	_____ 22
LONDON OFFICE	

- If an end station is assigned to an Abbreviated Dial Number,

press  and **1**.

Enter the Abbreviated Dial Number and press the  key.

- If an end station is assigned to a Group Number, press

 and **3**.

Enter the Group Number and press the  key.

RELAY END NUMBER	_____
1. ADD NEXT NUMBER	▲
2. COMPLETE	▼

3

9 When all the desired End Station Entries are completed under the same Relay Box, press the **2** key for “2. COMPLETE.”

TRANSMISSION REPORT	_____
ENTER TEL NUMBER OR,	_____
PRESS SPEED DIAL KEY	_____
OR ONE TOUCH KEY	_____

10 Enter the FAX Number of the remote location to which the Transmission Report should be sent. Then press key.

- Refer to Step 8 to designate the fax number.
- Relay Box set up is completed.

TRANSMISSION REPORT	_____
 767265	_____

Note

To provide a final transmission report to the originating station, each relay group must be personalized with the fax number of that remote station. Otherwise, the hub station does not know how to contact the originating station.

Deleting a Relay Box

This section describes the procedures to delete an exiting Relay Box in the hub unit.

1 Press the  key.

2 Select the MAILBOX SETUP.

Press:  then .

MAILBOX SETUP
1. COMPLETE
2. MAILBOX SETUP
3. MAILBOX DELETE

3 To select “3. MAILBOX DELETE,” press .

DELETE MAILBOX NUMBER
MAILBOX NUMBER (MAX20) :

4 Enter the number of the Relay Box number to be deleted.

DELETE MAILBOX NUMBER
PASSWORD (MAX20) :

5 Enter the password.

- When deletion is accepted, the message shown to the right is displayed.
- Make sure that the correct password is entered. Otherwise, the Message Display shows “Invalid number”.

DELETE MAILBOX NUMBER
Deleted

3

7. RELAY TRANSMISSION (Cont.)

Relay Transmission to a Remote Hub

This section describes the procedure to send a document to Relay Box in a remote hub.

- The remote hub must be compliant with ITU-T F-code communications.

Note

The destination relay box must be set up in the remote hub unit prior to sending a document.

3

1 Press the  key.

2 Place the original.
• For details on how to place the originals on the original glass.
(▶ See page 2-8.)

3 Set the scanning conditions. (▶ See pages 2-10 to 2-15.)

4 Display the MAILBOX Menu.

Press: 

MAILBOX TYPE
1. CONFIDENTIAL ▲
2. BULLETIN BOARD
3. RELAY ▼



5 To select “3. RELAY,” press the .

SEND (RELAY)
BOX NUMBER (MAX20):

6 Enter the box number and press the  key.

SEND (RELAY)
PROGRAM PASSWORD?
1. YES ▲
2. NO ▼

7 Select the password option.

- If the remote hub unit has a password programmed, press . Go to Step 8.
- If the remote hub does not have a password programmed, press . Go to Step 9.

SEND (RELAY)
PASSWORD (MAX20):

8 Enter the password for reservation and press the  key.

SEND (RELAY)
ENTER TEL NUMBER OR,
PRESS SPEED DIAL KEY
OR ONE TOUCH KEY

9 Dial the FAX number of the remote hub unit.

8. POLLING COMMUNICATIONS

- “Polling communications” is a function for receiving originals from a remote facsimile that has been called by the receiving facsimile. Polling communications allows the receiver FAX to retrieve documents whenever they are needed at the expense of the receiving station.
- Operations on the transmitter FAX are referred to as “polling transmission.” For the purpose of polling transmission, the sent originals are stored to memory.
- Operations on the receiver FAX are referred to as “polling RX.” There are two types of polling RX, “individual polling RX” and “multi-polling RX.”
- “Individual polling RX”: This function is for receiving originals from a single remote FAX.
- “Multi-polling RX”: This function is for receiving originals from two or more remote FAXes in a single operation. There are two ways of specifying groups: by registering remote FAXes beforehand to the speed dial as a group, and specifying that group, or by specifying two or more remote FAXes using the digital keys or the speed dial. The allowable number of destinations per group and maximum number of specifiable groups is the same as for “Group multi-address transmission.” (▶ See page 3-8.)

Polling Reservation



This section describes how to send originals to remote facsimile(s) when requested.

- Poll-once box: Once the originals are polled from a FAX, the originals are deleted from the memory. A 4-digit code can be assigned to this box as a security password, or the box can specify which remote FAX can poll from this box by the fax number of the remote fax.
- Multi-poll box: The originals stored in this box can be retrieved by several FAXes. The originals are not deleted even if they are retrieved. Any manufacturers' FAXes can retrieve from this box. However, there is no security function for this box.



1 Press the  key.

2 Place the original.
• For details on how to place originals on the original glass.
(▶ See page 2-8.)

3 Set the scanning conditions. (▶ See pages 2-10 to 2-15.)



4 Press the  key and to select “2. POLLING RESERVE;” press .

POLLING RESERVE	
1. POLLING	▲
2. PUBLIC FAX MAILBOX	▼

5 Select the box type.
• To reserve poll-once box, press . Go to Step 6.
• To reserve multi-poll box, press . Go to Step 8.

POLLING	
1. COMPLETE	▲
2. SECURITY	:OFF
3. SECURE TEL NUMBER	:OFF ▼

8. POLLING COMMUNICATIONS (Cont.)

6 Using  key, select the security option and the  key, if necessary.

7 **A. SECURITY CODE**
Enter a 4-digit Security Code using the digital key and press the  key.

POLLING		
1. COMPLETE		▲
2. SECURITY	: ON	
3. SECURE TEL NUMBER	: OFF	▼

B. SECURE TEL NUMBER

Enter the number of the polling (remote) facsimile using the digital keys and press the  key.

POLLING		
1. COMPLETE		▲
2. SECURITY	: OFF	
3. SECURE TEL NUMBER	: ON	▼

8 After setting the security option, press the  key.

- For reading the original on the glass, setting for the original size is required here.
(e-STUDIO16 only. ► See page 2-14.)
- The original starts to be scanned and is stored to memory.
- To cancel setting midway, press the  key.

SCANNING TO MEMORY		
JOB NUMBER	: XXX	
SCANNING PAGE	: YYY	
RESIDUAL MEMORY	: ZZZ%	

Tip

With multi-polling or poll-once (without security), only one transmission file can be stored to memory. Before you reserve the next polling transmission, first check that the first polling transmission was carried out.

Individual Polling RX

This procedure to retrieve a document from a remote facsimile. If the remote facsimile is a TOSHIBA facsimile and a 4-digit security code is programmed to the document to be polled, you must enter the correct 4-digit security code in order to retrieve the document.

1 Press the  key.

2 Displaying the POLLING Menu and select POLL.

Press:  then **1**

POLLING
SECURITY CODE ?
1 .YES
2 .NO

3 Select the Security Option.

- If the remote FAX is a TOSHIBA FAX and a 4-digit code is programmed to the document to be polled, press **1**. Go to Step 4.
- If the remote FAX is not a TOSHIBA or a security code is not used, press **2**. Go to Step 5.

POLLING
SECURITY CODE:

4 Enter the 4-digit security code for the document to be retrieved and press the  key.

POLLING
ENTER TEL NUMBER OR,
PRESS SPEED DIAL KEY
OR ONE TOUCH KEY

5 Specify the remote FAX. (► See pages 2-16 to 2-21.)

- The FAX will dial the remote FAX to retrieve the document.

POLLING
☎ 12345

8. POLLING COMMUNICATIONS (Cont.)

For details on how to specify remote FAXes using Multi-polling RX

In a Multi Polling operation, the documents are retrieved from multiple remote FAXes using pre-programmed groups, One Touch Keys, Abbreviated Dial, or from the Dial Keypad.

3



1 Press the  key.

2 Displaying the POLLING Menu and select POLL.

Press:  then 

POLLING	_____
SECURITY CODE ?	_____
1 . YES	_____
2 . NO	_____

3 Select the Security Option.

- If the remote FAX is a TOSHIBA FAX and a 4-digit code is programmed to the document to be polled, press . Go to Step 4.
- If the remote FAX is not a TOSHIBA or a security code is not used, press . Go to Step 5.

POLLING	_____
SECURITY CODE:	_____

4 Enter the 4-digit security code for the document to be retrieved and press the  key.

POLLING	_____
ENTER TEL NUMBER OR,	_____
PRESS SPEED DIAL KEY	_____
OR ONE TOUCH KEY	_____

5 Press the  key (on the Function key panel).

MULTI GROUP	_____	000
ENTER TEL NUMBER OR,	_____	_____
PRESS SPEED DIAL KEY	_____	_____
OR ONE TOUCH KEY	_____	_____

6 Specify the remote FAX number.

- Enter the numbers of the remote FAXes using any combination of the dialing method until all remote FAXes are entered.

Turnaround Polling

This operation allows you to poll another FAX after transmitting documents to it on the same phone call.

Note

Turnaround polling may not operate with non-TOSHIBA models.

1 Press the  key.

2 Place the original.
• For details on how to place originals on the original glass.
(▶ See page 2-8.)

3 Set the scanning conditions. (▶ See pages 2-10 to 2-15.)

4 Displaying the POLLING Menu and select TURN-AROUND POLL.

Press:  then **3**

TURNAROUND POLL
SECURITY CODE?
1 . YES
2 . NO

5 Select the Security Option.

- If the remote FAX is a TOSHIBA FAX and a 4-digit code is programmed to the document to be polled, press **1**. Go to Step 6.
- If the remote FAX is not a TOSHIBA or a security code is not used, press **2**. Go to Step 7.

TURNAROUND POLL
SECURITY CODE=
■■■■

6 Enter the 4-digit security code for the document to be retrieved and press the  key.

ENTER TEL NUMBER (MAX128):
FEB25-2001 11:30AM M :100%
RESOLUTION:STANDARD D/A :AUTO
COMM.OPTION▼

7 Specify the remote FAX. (▶ See pages 2-16 to 2-21.)

- The FAX will dial the remote FAX to perform an ordinary transmission.
- When the transmission is completed, polling of the document from the remote FAX will start immediately.

8. POLLING COMMUNICATIONS (Cont.)

Continuous Polling

This section describes the procedure to poll the same remote FAX(es) on a regular schedule. Continuous Polling operations can be programmed for specific time intervals on the days selected.

- A 4-digit security code can be used with other TOSHIBA MODEL facsimiles when the document has a security code programmed.
- Calls are performed within the set time period on the days selected with the set interval between callings.
- If multiple sending stations are programmed, callings are performed to all those stations within the set time period.
- If the polling operation exceeds the set time period, it will continue until all the facsimiles have been polled.
- Redialing or calling to alternate dialing numbers is not available during this operation.
- If a power failure occurs during this procedure, the polling continues when power is restored.
- If the set time period is shorter than the set calling interval, polling will be performed only once at the start time.



1 Press the  key.

2 Display the POLLING Menu and select **PROG. CONT. POLL.**

Press:  then 





```
PROG. CONT. POLL
1. CLEAR CURRENT SETTINGS ▲
2. ENTER TEL NUMBER (S)
3. START :MON 08:00AM ▼
```

3 To select “6. INTERVAL,” press .

- Set the interval using the  or  key and press the  key.





```
PROG. CONT. POLL.
INTERVAL 70MIN
BETWEEN CALL 10 ▼
10MIN
```

4 To select “3. START,” press .

- Set the date and time and press the  key.
- Using the  or  key to select the set item.
- Using the  or  key to select the setting value.
- The time format varies according to whether the 12-hour clock or 24-hour clock is selected. (Refer to the Operator’s Manual (For Copying Functions).)



```
PROG. CONT. POLL.
START DATE & TIME
MON ▼ 08:00 AM ▼
```

5 To select “5. DURATION,” press .

- Select the duration period and press the  key.
- Using the  or  key to select the set item.
- Using the  or  key to select the setting value.
- End time is automatically calculated.

```
PROG. CONT. POLL.
DURATION
09:00 ▼
```

6 To select "4. END," press 4.

- Set the end date using  or  key.
- The end time is automatically calculated and displayed after pressing the  key.

PROG. CONT. POLL.
END DATE
FRI

7 To select "7. SECURITY," press 7.

- Set the 4-digit security code if necessary.

PROG. CONT. POLL.
SECURITY CODE

8 To select "2. ENTER TEL NUMBER(S)", press 2.

- Enter the number of the remote FAX. (► See pages 2-16 to 2-21.)

PROG. CONT. POLL.
ENTER TEL NUMBER OR,
PRESS SPEED DIAL KEY
OR ONE TOUCH KEY

PROG. CONT. POLL.
1. ADD NEXT NUMBER ▲
2. COMPLETE ▼

9 When all the addresses are entered, select "2. COMPLETE". To enter the next remote FAX address, select "1. ADD NEXT NUMBER" and return to step 8.

- The procedure is now complete. The display returns to the Standby Mode. The facsimile will automatically start polling at the time set in this procedure.

Operation completed
JOB NUMBER :XXX

8. POLLING COMMUNICATIONS (Cont.)

Clear the Settings of the Continuous Polling

This operation clears the all the settings of the continuous polling function. All items are restored to their default settings.

3

1 Press the  key.

2 Display the POLLING Menu and select PROG. CONT. POLL.

```
PROG. CONT. POLL.
1.CLEAR CURRENT SETTINGS ▲
2.ENTER TEL NUMBER(S)
3.START :MON 08:00AM ▼
```

Press:  then 

3 To select "1. CLEAR CURRENT SETTINGS," press .

```
PROG. CONT. POLL.
CLEAR CURRENT SETTINGS ?
1.YES
2.NO ▼
```

4 To select "1.YES," press .

- All the settings are cleared to defaults.

```
PROG. CONT. POLL.
Settings cleared.
```

9. CHAIN DIALING

This function allows you to dial telephone/facsimile numbers that may require many digits with pauses for voice prompts or variations in number sequences such as long distance access codes, or specialized access lines. You can combine sets of numbers (Abbreviated Dialing, Alphabet Dialing, One Touch Dialing, and Keypad Dialing) by using the  Key.

1 Press the  key.

2 Place the original.

- For details on how to place originals on the original glass. (▶ See page 2-8.)

3 Set the scanning conditions. (▶ See pages 2-10 to 2-15.)

4 Press the  Key (on the Function key panel).

```
CHAIN DIAL COMM.
ENTER TEL NUMBER OR,
PRESS SPEED DIAL KEY
OR ONE TOUCH KEY
```

5 Enter the Dial number.

Start constructing your dialing sequence using any of the following dialing methods.

You may use them consecutively until your enter dialing string has been entered.

After each entry sequence, the LCD screen displays the screen shown in step 4.

- Abbreviated Dialing (▶ See page 2-18.)
- Alphabet Dialing (▶ See page 2-19.)
- One Touch Dialing (▶ See page 2-21.)
- Keypad Dialing (▶ See page 2-16.)

Remember to add pauses (if required) to allow for voice prompts or other system delays. (▶ See page 2-17.)

```
TELEPHONE NUMBERS LIST
1. ABB. NUMBER
2. SEARCH NAME
```

```
CHAIN DIAL COMM.
ABB.NUMBERS = (1-999)
```

```
CHAIN DIAL COMM.
ONE TOUCH KEY = 01
LONDON OFFICE
```

```
CHAIN DIAL COMM.
12345
```

6 When all the required entries are performed, press the  key.

- The facsimile starts scanning the document into memory, and automatically send document to the designated FAXes.

```
SCANNING TO MEMORY
JOB NUMBER : XXX
SCANNING PAGE : YYY
RESIDUAL MEMORY : ZZZ%
```



3

ENTERING & SETTING ITEMS

1. ENTERING CHARACTERS	4-3
Keys used for Character Entry	4-3
Special Character Table	4-4
Entering Characters	4-5
Correct Entered Characters	4-6
2. ENTERING THE REMOTE FAX NUMBER	4-7
Entering to TEL LIST	4-7
Entering Abbreviated Dialer Registration	4-8
Entering One Touch Dialer Registration	4-10
Groups Number Registration	4-12
Correcting Groups (Modify the Remote Station)	4-14
Correcting Groups (Delete the Remote Station)	4-16
Deleting Groups	4-17
3. ENTERING VARIOUS FUNCTIONS	4-18
Terminal ID Entry	4-18
Dial Type Entry	4-19
Exchange Type Entry (EU MODEL ONLY)	4-20
Line Monitor	4-21
Temporary Line Monitor Change	4-21
Receive Interval Setting	4-22
ECM Setting	4-22
Temporary ECM Change	4-23
Default Setting for Document Mode	4-24
Redial Mode Setting	4-25
Default Setting for Memory Transmission	4-26
Temporary Security TX Change	4-27
Security TX (Transmission) Setting	4-27
Cover Sheet Registration	4-28
Attaching or Printing Cover Sheet	4-29
Setting Recovery Transmission	4-31
Sending Recovery Transmission	4-32
TTI (Transmit Terminal ID) Print Setting	4-33
Send After Scan Default Setting	4-34
Enabling or Disabling Send After Scan Temporarily	4-35
Account Codes	4-36
Account Code Entry	4-37
Separator Page Setting	4-38
Secure RX Security Code Setting	4-39
Secure RX Activation Period Setting	4-40
Secure RX Manual Activation	4-42

Secure RX Print	4-43
Reception Reduction Setting	4-44
Reception Discard Setting	4-44
Privileged Reception	4-45
RTI (Remote Terminal ID) Print Setting	4-46
Long Original Setting	4-47
Setting the Page Count	4-48
Pin Mask	4-49
Dialing with Sub-address	4-50
4. OUTPUTTING LISTS & REPORTS	4-52
List & Report Options Setting	4-52
Reception Journal Setting	4-53
Direct Transmission Report Setting	4-54
Memory Transmission Report Setting	4-55
Multi-Address Transmission Report Setting	4-56
Multi-Polling Report Setting	4-56
Relay Originator Report Setting	4-57
Relay Station Transmission Report Setting	4-57
Reception List Setting	4-58
Transmission/Relay Destination Report Setting	4-58
Tel List	4-59
Reservation List	4-59
Department Code List	4-59
List and Report Printing Procedure	4-59
Function List	4-60
Mailbox/Relay Box List	4-60
Fax Option List	4-60
Menu List (PROGRAM)	4-60
List and Report Print Format	4-61
Transmission/Reception Journal	4-61
Transmission Report	4-64
Memory Transmission Report	4-65
Multi-Address Transmission Report	4-66
Multi-Polling Report	4-68
Relay Transmission Originator Report	4-70
Relay Station Report	4-71
Relay Transmission Relay Station Report	4-72
Relay Transmission Relay End Terminal Report	4-74
Mailbox/Relay Box List	4-75
Department Control List	4-76
Reservation List	4-77
Alphabetical Sort List	4-79
Abbreviated Dial Number List	4-80
Group Number List	4-82
One Touch Number List	4-83
Function List	4-84
Fax Option List	4-85
Menu List (PROGRAM)	4-86
Power Failure List	4-87

1. ENTERING CHARACTERS

The Character Entry screen is for entering characters when you are setting and entering items. You can enter the following:

Alphabet characters, numbers and symbols.

Keys used for Character Entry



key Press this key to fix all entered characters.



key Press this key to clear all characters that have been entered so far.



key Move the cursor to the right. If pressed without entering a character, it inserts a space.



key Move the cursor to the left.

Numeric key Provides the user interface for entering numeric characters.

Function key Provides the user interface for entering alpha and special characters.



key Inserts characters before the selected (highlighted) character.



key Delete the selected character.



key Press this key to delete the character before the cursor.



key Press this key and the alphabet keys to enter the capital letter, or press this key and the symbol keys to enter the upper side symbols indicated above the each key.

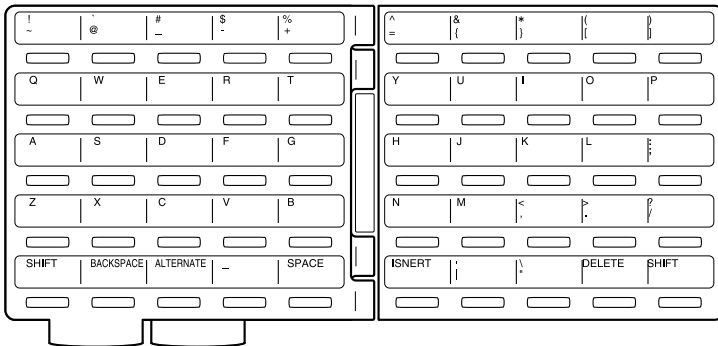



1. ENTERING CHARACTERS (Cont.)

Special Character Table

The Character Table lists special characters that can be entered when programming this facsimile. The table lists the alpha keys in the left column and the characters that correspond to each key in the right column.

To enter the special characters entry mode, press the **[ALTERNATE]** key on the keyboard. Pressing the alpha key displays the special characters you can enter.

Select your desired character by using the  or  keys, and press .

Uppercase special characters can be selected by pressing the alpha key while holding down the **[SHIFT]** key after the **[ALTERNATE]** key is pressed.

Key	[ALTERNATE] key	[SHIFT] key
A	à á â ã ä å æ ç ä ^a	À Á Â Ã Ä Å Æ Ç À
C	ç ı ć č	Ć Ç Č
D	đ d	Đ Đ
E	è é ê ë ě	È É Ê Ë Ě €
I	ì í î ï	Ì Í Î Ï
L	ł ł́	Ł Ł́
N	ñ n̄ ñ	Ñ Ñ̄ Ñ̄
O	œ ° ð ò ó ô õ ö ø	Ò Ó Ô Õ Ö Ø Æ Ò
P	p	
R	ř ř	Ř Ř
S	š š̄ š̄	Š Š̄ Š̄
T	ť ť	Ť Ť
U	ù ú û ü ú́	Ù Ú Û Ü Ú́
Y	ý ŷ	Ý ŷ
Z	ž ž̄ ž̄	Ž Ž̄ Ž̄

Entering Characters

Example: Enter "Chicago"

1 Press key while pressing the key.

2 Press , , , , and keys to enter.

3 Press the to quit character entry.







1. ENTERING CHARACTERS (Cont.)

Correct Entered Characters

Correct "CHICADO" to "CHICAGO."

1 Press the  key to delete "hicado."

C

2 Press , , , , , and then  while pressing the  key.

CHICADO

3 Press the  key to move the cursor over the "O."

CHICADO

4 Press the  key to delete the "D."

CHICAO

5 Press the  key.

CHICAO [INSERT]

6 Press , while pressing the  key.

CHICAGO [INSERT]

7 Press the  key and exit the Insert Mode.

CHICAGO

8 Press the  key to quit the character entry.

2. ENTERING THE REMOTE FAX NUMBER

Entering to TEL LIST

Abbreviated Dial Numbers

This facsimile can store up to 300 facsimile numbers (up to 128-digit long) and associated 20-character location ID names. This information is stored into Abbreviated Dial Numbers labeled from 001 to 999.

One Touch Numbers

This facsimile provides a total of 75 One Touch Dial keys. Keys 1 to 50 are accessible with the Flip Panel in the "01-50" view. Keys 51 to 75 are accessible with the Flip Panel in the "51-75" view.

Group Numbers

You can send a document to multiple remote parties in a single operation. This is referred to as Group Dialing or Multi-address Transmission.

It is useful to preset addresses, to which Multi-address Transmissions are often performed, in a group. To make a Multi-address Transmission easier, you can assign such a group to a One Touch key.

The preset groups can also be used as groups for Multi-polling Receptions.

You can register up to 50 Broadcast Groups using any combination of Group Numbers from 1 to 1999 (no duplications allowed). You may also assign each group an optional name of up to 20 characters. Each group can contain any combination of the 300 Abbreviated and/or 75 One Touch dial locations and can be assigned to a One Touch key.

2. ENTERING THE REMOTE FAX NUMBER (Cont.)

Entering Abbreviated Dialer Registration

1 Press the  key.

2 Displaying the Abbreviated Numbers Menu.

Press:  then 

ABB. NUMBER	001
ENTER ABB. NUMBER (1-999) :	

3 Enter an Abbreviated Dial Number from 1 to 999 and press the  key.

ABB. NUMBER	001
1. COMPLETE	
2. NAME	
3. TEL NUMBER	
4. 2nd TEL NUMBER	
5. COMM. OPTIONS	



4 To select “2. NAME,” press . Then enter the name of the remote FAX (up to 20 characters) and press the  key.

ABB. NUMBER	001
ENTER ID NAME (MAX20) :	
LONDON OFFICE	



5 To select “3. TEL NUMBER,” press . Then enter the telephone number you want to store (up to 128 digits) and press the  key.

ABB. NUMBER	001
ENTER TEL NUMBER (MAX128) :	
767717	





6 To select “4.2nd TEL NUMBER,” press . Then enter the alternate fax number if the remote location has two or more faxes (optional setting) and press the  key.

ABB. NUMBER	001
ENTER 2nd TEL NUMBER :	
767669	

7 To select “5.COMM. OPTIONS,” press .

• To skip the Communication Options, press .

• To select default settings, press . If one or more of the following Communication Options are to be set for this Abbreviated Dial Number.

COMM. OPTIONS	001
1. OFF	
2. ON	

COMM. OPTIONS	001
1. COMPLETE	
2. DELAYED COMM.	
3. TX REPORT	

Note

“NAME” and “TEL NUMBER” must be entered. Unless either one is entered, registration will not be completed. In this case, upon selecting “COMPLETE”, the display shows “No destination” for a while, then will be restored to the status just before the operation.

A To select “2. DELAYED COMM,” press 2.

- Select to program a transmission start time.
(Refer to the description of the  key.)

DELAYED COMM.	
TIME	: HH :MM
	10 :10 AM
	◀ ▶

B To select “3. TX REPORT,” press 3.

- Set whether or not to print a TX report.
(Refer to the description of the  key.)

TX REPORT	
1. OFF	▲
2. ON	▼

C To select “4. LINE MONITOR,” press 4.

- Select to program the line monitor speaker during dialing.



LINE MONITOR	
1. OFF	▲
2. ON	▼

D To select “5. QUALITY TX,” press 5.

- Select to program a lower speed communication.
(Refer to the description of the  key.)

QUALITY TX	
1. OFF	▲
2. 14400 BPS	
3. 9600 BPS	▼

E To select “6. SUB ADDRESS,” press 6.

- Selected only when the remote FAX requires one.
(Refer to the description of the  key.)
- To cancel programming press the  key.

SUB ADDRESS	
1. COMPLETE	▲
2. SUB ADDRESS (SUB)	
3. SELECTIVE POLLING (SEP)	▼

8 After you have done all required settings, select “1. COMPLETE.” The first ABB. NUMBER ENTRY screen is displayed.

ABB. NUMBER	001
PRESS ONE TOUCH KEY	
TO ENTER OR	
[SET] : TO SKIP	



9 Press the desired One Touch Key if you want to assign the registered Abbreviated Dial to a One Touch ( to ) Key. Press the  key if you do not want to assign the registered Abbreviated Dial to a One Touch Key.

ABB. NUMBER	001
ONE TOUCH :	02
LONDON OFFICE	

2. ENTERING THE REMOTE FAX NUMBER (Cont.)

Entering One Touch Dialer Registration

1 Press the  key.

2 Displaying the One Touch keys Menu.

Press:  then **3**

```
ONE TOUCH KEY
PRESS ONE TOUCH KEY
```

3 Press the desired One Touch ( to ) key.

```
ONE TOUCH KEY 001
1. COMPLETE ▲
2. NAME
3. TEL NUMBER ▼
4. 2nd TEL NUMBER
5. COMM. OPTIONS
```

4 To select “2.NAME,” press **2**. Then enter the name of the remote FAX (up to 20 characters) and press the  key.

```
ONE TOUCH KEY 05
ENTER ID NAME (MAX20) :
LONDON OFFICE █
```

5 To select “3.TEL NUMBER,” press **3**. Then enter the telephone number you want to store (up to 128 digits) and press the  key.

```
ONE TOUCH KEY 05
ENTER TEL NUMBER (MAX128) :
767717 █
```

6 To select “4.2nd TEL NUMBER,” press **4**. Then enter the alternate fax number if the remote location has two or more faxes (optional setting) and press the  key.

```
ONE TOUCH KEY 05
ENTER 2nd TEL NUMBER:
767669 █
```

7 To select “5.COMM. OPTIONS,” press **5**.

• To skip the Communication Options, press **1**.

```
COMM. OPTIONS
1. OFF ▲
2. ON ▼
```

• To select default settings, press **2**. If one or more of the following Communication Options are to be set for this Abbreviated Dial Number.

```
COMM. OPTIONS
1. COMPLETE ▲
2. DELAYED COMM.
3. TX REPORT ▼
```

Note

“NAME” and “TEL NUMBER” must be entered. Unless either one is entered, registration will not be completed. In this case, upon selecting “COMPLETE,” the display shows “No destination” for a few seconds, then it will be restored to the status just before the operation.

A To select “2. DELAYED COMM,” press 2.

- Select to program a transmission start time.
(Refer to the description of the  key.)

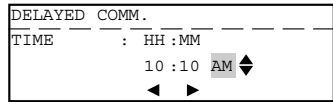

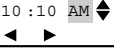
DELAYED COMM. _____
TIME : HH:MM
10:10 AM 

B To select “3. TX REPORT,” press 3.

- Set whether or not to print a TX report.
(Refer to the description of the  key.)





TX REPORT _____
1. OFF 
2. ON 

C To select “4. LINE MONITOR,” press 4.

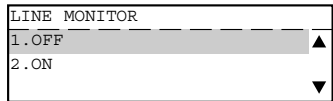
- Select to program the line monitor speaker during dialing.





LINE MONITOR _____
1. OFF 
2. ON 

D To select “5. QUALITY TX,” press 5.

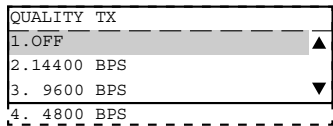
- Select to program a lower speed communication.
(Refer to the description of the  key.)





QUALITY TX _____
1. OFF 
2. 14400 BPS 
3. 9600 BPS 
4. 4800 BPS _____

E To select “6. SUBADDRESS,” press 6.

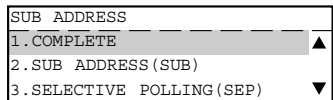
- Selected only when the remote FAX requires one.
(Refer to the description of the  key.)



SUB ADDRESS _____
1. COMPLETE 
2. SUB ADDRESS (SUB) 
3. SELECTIVE POLLING (SEP) 

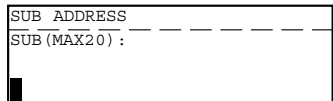

SUB ADDRESS _____
SUB (MAX20) : _____
█

- To cancel programing press the  key.

8 After you have completed all the desired settings, select “1.COMplete.”

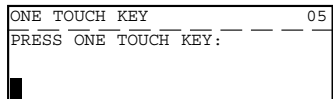

ONE TOUCH KEY _____ 05
PRESS ONE TOUCH KEY: _____
█

2. ENTERING THE REMOTE FAX NUMBER (Cont.)

Groups Number Registration

1 Press the  key.

2 Displaying the Group Numbers Menu.

Press:  then **2**

```
GROUP NUMBER
ENTER GROUP NUMBER(1-1999)
```

3 Enter a Group Number from 1 to 1999 and press the  key.

```
GROUP NUMBER
1. COMPLETE
2. NAME
3. DESTINATIONS
```

4 To select "2.NAME," press **2**. Then enter the name of the remote FAX (up to 20 characters) and press the  key.

```
GROUP NUMBER 0001
ENTER ID NAME (MAX20):
ABC GROUP
```

5 To select "3.DESTINATIONS," press **3**. Then enter the addresses of the remote stations to be preset in the group.

- If a remote station is assigned to a One Touch (⁰¹ to ⁷⁵) key, press the One Touch key.

```
GROUP NUMBER
ENTER ABB. NUMBER
OR ONE TOUCH KEY
```

- If a remote station is assigned to an Abbreviated Dial number, enter the number then press the  key.

```
GROUP NUMBER 0001
ONE TOUCH: 02
LONDON OFFICE
```

```
GROUP NUMBER 0001
ABB. NUMBER: 021
CHICAGO OFFICE
```

After 2 sec

```
GROUP NUMBER 0001
1. ADD NEXT NUMBER
2. REVIEW LIST
3. COMPLETE
```

After 2 sec

6 When all the addresses are entered, select "3.COMPLETE" and go to next step. To enter the next remote station address, select "1.ADD NEXT NUMBER" and return to step 5.

```
GROUP NUMBER
1. COMPLETE
2. NAME
3. DESTINATIONS
```

7 To select "1. COMPLETE" press **1**.

```
GROUP NUMBER 0001
PRESS ONE TOUCH KEY
TO ENTER OR
[SET]: TO SKIP
```

7 To assign this group to a One Touch key, press the desired One Touch (to) key.

To skip assigning this group to a One Touch key,

press the  key.

- Press the  key to return to the initial screen for FAX.

GROUP NUMBER
ENTER GROUP NUMBER (1-1999):

Note

“NAME” and “TEL NUMBER” must be entered. Unless either one is entered, registration will not be completed. In this case, upon selecting “COMPLETE,” the display shows “No destination” for a few seconds, then it will be restored to the status just before the operation.

2. ENTERING THE REMOTE FAX NUMBER (Cont.)

Correcting Groups (Modify the Remote Station)

1 Press the  key.

2 Displaying the Group Numbers Menu.

Press:  then **2**

```
GROUP NUMBER
ENTER GROUP NUMBER (1-1999) :
```

3 Enter the Group Number you want to correct.
Then press the  key.

```
GROUP NUMBER          0001
LONDON OFFICE
Already assigned
```

4 To select "2. MODIFY," press **2**.

```
GROUP NUMBER          0001
1. DELETE              ▲
2. MODIFY              ▼
3. RETAIN              ▲
```

5 A. Modify the Existing Group Name.

• To select "2.NAME," press **2**.

```
GROUP NUMBER          0001
1. COMPLETE           ▲
2. NAME               ▼
3. DESTINATIONS      ▲
```

• Modify the Group Name and press the  key.

```
GROUP NUMBER          0001
ENTER ID NAME (MAX20) :
ABC GROUP             ▼
```

B. Modify the Remote Station.

• To select "3.DESTINATIONS," press **3**.



• To add a new address to the group, select "1.ADD NEXT NUMBER" by pressing **1** and go to step 8.

• To select "2.REVIEW LIST," press **2**. Go to step 6.

```
GROUP NUMBER          0001
1. COMPLETE           ▲
2. NAME               ▼
3. DESTINATIONS      ▼
```

```
GROUP NUMBER          0001
1. ADD NEXT NUMBER   ▲
2. REVIEW LIST       ▼
3. COMPLETE          ▼
```

```
001. COLORADO OFFICE ▲
002. CHICAGO OFFICE ▼
003. L.A. OFFICE    ▼
[DELETE] [←] [→] [MODIFY]
```

6 Select the address to be modified by using  or  key.

7 Press the  key, and modify the setting.

- If the address assigned to an ABB. number is selected;

GROUP NUMBER	0001
ABB. NUMBER	003
CHICAGO OFFICE	

After 2 sec

GROUP NUMBER	0001
ENTER ABB. NUMBER (1-999):	

- If the address assigned to a One Touch key is selected;

GROUP NUMBER	0001
ONE TOUCH:	20
L. A. OFFICE	

After 2 sec

GROUP NUMBER	0001
PRESS ONE TOUCH KEY	



8 Enter the ABB. NUMBER and press the  key, or press ONE TOUCH key.

GROUP NUMBER	0001
ABB. NUMBER	021
JAPAN OFFICE	

After 2 sec

001.LONDON OFFICE	▲
002.CHICAGO OFFICE	
003.L.A.OFFICE	▼
<input type="button" value="DELETE"/> <input type="button" value="MODIFY"/>	

9 Complete modifying Remote Station.



- Press  key and to select "3.COMPLETE," press .

GROUP NUMBER	0001
1.COMPLETE	021
2.NAME	
3.DESTINATION	

10 Complete modifying Groups.

- To select "1.COMPLETE," press .

GROUP NUMBER	0001
PRESS ONE TOUCH KEY	
TO ENTER OR	
[SET]: TO SKIP	











- To assign this group to a One Touch key, press the desired One Touch ( to ) key. To skip assigning this group to a One Touch key, press the .

GROUP NUMBER	
ENTER GROUP NUMBER (1-1999):	

- Press the  key to return to the initial screen for FAX.

2. ENTERING THE REMOTE FAX NUMBER (Cont.)

Correcting Groups (Delete the Remote Station)

- 1 Press the  key.
- 2 Displaying the Group Numbers Menu.
Press:  then .
- 3 Enter the Group Number you want to correct.
Then press the  key.
- 4 To select "2. MODIFY," press .
- 5 To select "3. DESTINATIONS," press .
- 6 To select "2. REVIEW LIST," press .
- 7 Select the address to be deleted by using the  or  key. And then press the  key.

```
GROUP NUMBER _____
ENTER GROUP NUMBER (1-1999) :
```

```
GROUP NUMBER _____ 0001
LONDON OFFICE
Already assigned
```

```
GROUP NUMBER _____ 0001
1. DELETE _____ ▲
2. MODIFY _____ ▼
3. RETAIN _____ ▼
```

```
GROUP NUMBER _____ 0001
1. COMPLETE _____ ▲
2. NAME _____ ▼
3. DESTINATIONS _____ ▼
```

```
GROUP NUMBER _____ 0001
1. ADD NEXT NUMBER _____ ▲
2. REVIEW LIST _____ ▼
3. COMPLETE _____ ▼
```

```
001. COLORADO OFFICE _____ ▲
002. CHICAGO OFFICE _____ ▼
003. L.A. OFFICE _____ ▼
[DELETE] [◀] [▶] [MODIFY]
```

```
GROUP NUMBER _____ 0001
ABB. NUMBER _____ 003
CHICAGO OFFICE
```

After 2 sec

```
DELETE?
CHICAGO OFFICE _____
1. YES _____
2. NO _____
```

8 To select "1. YES" press **1**.

GROUP NUMBER	0001
ABB. NUMBER	003
CHICAGO OFFICE	
Deleted	

After 2 sec

001.CHICAGO OFFICE	▲
002.L.A.OFFICE	
003.JAPAN OFFICE	▼
DELETE	▶
	MODIFY

- Press the ^{MAIN MENU}  key to return the initial screen for FAX.

Deleting Groups

1 Press the ^{FAX}  key.

2 Displaying the Group Numbers Menu.

Press: ^{TEL LIST}  then **2**

GROUP NUMBER	0001
ENTER ABB. NUMBER	
OR ONE TOUCH KEY	

3 Enter the Group Number you want to delete.
Then press the ^{SET}  key.

GROUP NUMBER	0001
NEW YORK	
Number already selected	

4 To select "1. DELETE," press **1**.

GROUP NUMBER	0001
1.DELETE	▲
2.MODIFY	
3.RETAIN	▼

GROUP NUMBER	0001
NEW YORK	
Deleted	

3. ENTERING VARIOUS FUNCTIONS

Terminal ID Entry

Once programmed, Terminal ID information will be printed on the leading edge of all documents transmitted by this digital copier/facsimile.

- Details to Enter: ID name (max. 40 characters)
Printing of international code (ON/OFF)
ID number (max. 20-digit number)

Tip

- ID information is sent printed about 5 mm from the top edge of the original.
- In compliance with FCC regulations (see page 1), this facsimile places your company's name, facsimile telephone number and date & time on the top of all transmitted documents. This feature enables remote parties to easily identify your documents and the time of transmission.

4

1 Displaying the TERMINAL ID Menu.



Press: ^{PROGRAM}  then    

TERMINAL ID
NAME (MAX40)
█

2 Enter your Terminal ID (company name) (up to 40 characters) using the Keyboard and Numeric Keypad. Then press the ^{SET} key.

TERMINAL ID
INT. CODE?
1. YES
2. NO

3 Select the COUNTRY CODE.

- If you send or receive documents to and from overseas locations, select "1. YES" by pressing .
- If all of the documents are sent domestically, select "2. NO," by pressing .

TERMINAL ID
TEL NUMBER (MAX20):
+811234 █

4 Enter your telephone number and press the ^{SET} key.

- If you press  in Step 3, + is displayed on the screen. Enter International Code for your country before entering your area code and telephone number.

INITIAL SETUP
01. DATE & TIME
02. LANGUAGE
03. TERMINAL ID

Dial Type Entry



There are two types of dialing modes: MF (Multi-frequency) and DP (Dial Pulse). If your telephone emits tones when you are dialing, this usually indicates that you have a MF type (default setting). Otherwise, you will have to select the DP setting.

1 Display the DIAL TYPE Menu.

Press: ^{PROGRAM}  then      

DIAL TYPE
1.MF
2.DP

2 Select your dial type.

- For Multi-Frequency type, press . (default)
- For Dial Pulse type, press .

DIAL TYPE
DELETE ACCESS DIGIT
ACCESS DIGIT (MAX10):
█

3 Enter any "DELETE ACCESS DIGIT" number.

- Access digit are numbers which are required by PBX systems to access the phone system "outside" the PBX.
- Access digits such as 9 and pause need to be omitted when using the chain dialing function.
- If you do not require the "DELETE ACCESS DIGIT" function, press the ^{SET}  key to skip this setting.

FAX SETUP
03.ECM
04.DOCUMENT MODE
05.DIAL TYPE

3. ENTERING VARIOUS FUNCTIONS (Cont.)

Exchange Type Entry (EU MODEL ONLY)

Connection to PABX, obtaining a public line/Digital PABXs

The fax unit can be connected not only to the public switched telephone network (public line) but also to a PABX. In this case, additional parameters have to be entered.

With PABXs, the public line is obtained in various ways:

- Number Dial one digit (or several digits) in order to obtain the public line
- Flash key With this method of obtaining the public line, the connection circuit is interrupted briefly.

When the method of obtaining a public line has been entered, you must always press  key before the actual number when you dial your fax partner. This is also applicable for saving the fax numbers.



4

1 Display the EXCHANGE TYPE Menu.

Press:  then      



EXCHANGE TYPE
1. PSTN
2. PABX

2 Select the EXCHANGE TYPE.

- To select "1.PSTN," press .
Return to FAX SETUP Menu.
- To select "2.PABX," press .

EXCHANGE TYPE
1. FLASH
2. DIGIT

3 Select the ACCESS TYPE.

- To select "1.FLASH," press .
Return to FAX SETUP Menu.
- To select "2.DIGIT," press . Go to step 4.

EXCHANGE TYPE
SET ACCESS DIGIT
ACCESS DIGIT = (1-3)

4 Enter the digit(s) for obtain public line.

- Enter the digit(s) then press  key.

FAX SETUP
05. DIAL TYPE
06. REDUAK MODE
07. AUTO RECEIVE MODE

Line Monitor

This function is used to set the speaker ON in order to monitor the dialing and connection portion of every transmission. This function is mainly used to confirm dialing and phone line status.

1 Display the LINE MONITOR Menu.

Press:  then **0 1 0 3 0 1**

LINE MONITOR	
1.OFF	▲
2.ALWAYS	▼

2 Select the Line Monitor option.

- To turn OFF the monitor speaker, press **1**.
- To turn ON the monitor speaker, press **2**.

FAX SETUP	
01.LINE MONITOR	▲
02.RECEIVE INTERVAL	▼
03.ECM	▼

4

Temporary Line Monitor Change

Note

This temporary setting is only available when the default setting is "Off".

1 Press the key.

2 Place the original.

- For details on how to place the originals on the glass.
(▶ See page 2-8.)

3 Set the scanning conditions. (▶ See pages 2-10 to 2-15.)

4 Press the key to display the COMM. OPTIONS.

1.SECURITY TX	:OFF	▲
2.ECM	:ON	▼
3.LONG ORIGINAL	:OFF	▼
4.LINE MONITOR	:OFF	▼

5 To select "4. LINE MONITOR," press **4**.

LINE MONITOR	
1.OFF	▲
2.ON	▼

6 Select "1.OFF" or "2.ON" to change the setting.

- To select "1.OFF," press **1**.
- To select "2.ON," press **2**.

ENTER TEL NUMBER (MAX128) :	
FEB25-2001 11:30AM M :100%	
RESOLUTION:STANDARD  :AUTO	
COMM.OPTION ▼	

7 Specify the remote FAX. (▶ See pages 2-16 to 2-21.)

3. ENTERING VARIOUS FUNCTIONS (Cont.)

Receive Interval Setting

This function insures, there will be a period of time set aside for receiving incoming facsimiles during periods of heavy outgoing transmission activity. After every fourth consecutive transmission, this machine will wait 0 to 15 minutes to allowing in-coming facsimiles to be received (Default is different for each country).

1 Display the RECEIVE INTERVAL Menu.

Press: then

RECEIVE INTERVAL	_____
INTERVAL:	15 MIN
03	▲
	▼
	0 MIN

2 Using the or key, select the desired interval value (0 to 15) in minutes, then press the key.

FAX SETUP	_____
01 . LINE MONITOR	▲
02 . RECEIVE INTERVAL	▼
03 . ECM	

ECM Setting

ECM (Error Correction Mode) is an internationally-recognized error correction system. It enables error free communications by automatically resending any portion of the document affected by phone line noise or distortion.

Note

This setting is not available if fax communications are underway.

1 Display the ECM Menu.

Press: then

ECM	_____
1 . OFF	▲
2 . ON	▼

2 Select the ECM option.

- To turn ECM to OFF, press .
- To turn ECM to ON, press .

FAX SETUP	_____
01 . LINE MONITOR	▲
02 . RECEIVE INTERVAL	▼
03 . ECM	

Temporary ECM Change

1 Press the  key.

2 Place the original.
• For details on how to place the originals on the glass.
(▶ See page 2-8.)

3 Set the scanning conditions. (▶ See pages 2-10 to 2-15.)



4 Press the  key to display the COMM. OPTIONS.

1. SECURITY TX	:OFF	▲
2. ECM	:OFF	
3. LONG ORIGINAL	:OFF	
4. LINE MONITOR	:OFF	▼

5 To select “2. ECM,” press .

ECM	
1. OFF	▲
2. ON	▼

6 Select “1.OFF” or “2.ON” to change the setting.

- To select “1.OFF,” press .
- To select “2.ON,” press .

ENTER TEL NUMBER (MAX128) :	
FEB25-2001 11:30AM M :100%	
RESOLUTION:STANDARD (1) :AUTO	
COMM. OPTION ▼	



7 Specify the remote FAX.
(▶ See pages 2-16 to 2-21.)

3. ENTERING VARIOUS FUNCTIONS (Cont.)

Default Setting for Document Mode



This setting will select the default setting whenever a document is set in the facsimile for transmission. Manual settings (if selected for a particular document) will take precedence over default settings.

1 Display the REDIAL MODE Menu.

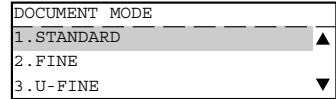
Press: PROGRAM  then      





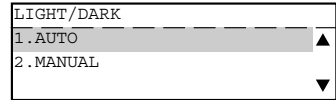

2 Select the DOCUMENT MODE.

- To select STANDARD mode for sending normal text and graphics, press .
- To select FINE mode for sending normal text and graphics with clarity, press .
- To select U-FINE mode for sending normal text and graphics with extra clarity, press .



3 Select the Image Density.

- To select the AUTO mode, press .
- To select the MANUAL mode, press .
- Use the  or  key to select the desired image density, then press  key.

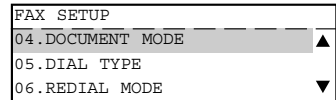
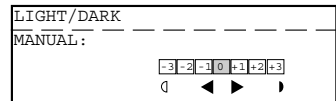
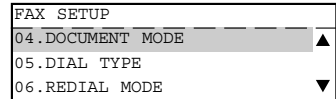

Redial Mode Setting



If the destination facsimile you called is busy, your facsimile will automatically redial the number up to the number of attempts set by this procedure. (Default is different for each country.) If desired, you may change these redial settings.

1 Display the REDIAL MODE Menu.

Press:  then      

REDIAL MODE	
1. INTERVAL	▲
2. COUNTER	▼

2 Select the Redial Menu.

- To set the Redial Interval, press .
- To set the Redial Count, press .

REDIAL MODE	
INTERVAL :	15 MIN
03	◆
	01 MIN

REDIAL MODE	
COUNTER :	14
02	◆
	01

3 Using the or key, enter the desired interval or counter value and press the key.

REDIAL MODE	
1. INTERVAL	▲
2. COUNTER	▼

3. ENTERING VARIOUS FUNCTIONS (Cont.)

Default Setting for Memory Transmission

Memory Transmission allows your facsimile to quickly scan documents to memory and return them to you. You do not have to wait for the transmission to be completed. This increases productivity as others do not have to wait in line to send a facsimile. Each time you send a facsimile with memory transmission, the amount of residual memory will be reduced.

Additionally, each time you send a memory transmission, a communication reservation or File Number is assigned.

When Memory Transmission is not selected, the Direct Document Transmission mode is active by default setting. This allows your facsimile to function without the use of document memory.



4

1 Display the MEMORY TX Menu.

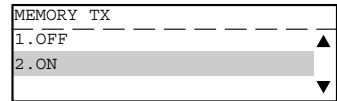
Press: ^{PROGRAM}  then     



2 Select the Memory Tx option.

- To select Memory TX OFF, press .
- To select Memory TX ON, press .

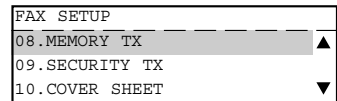

Security TX (Transmission) Setting



This function allows transmissions only when the number you dial matches the number programmed in the remote facsimile. If the numbers do not match, Security TX prevents your facsimile from sending by indicating a transmission error.

1 Display the SECURITY TX Menu.

Press:  then      

SECURITY TX	
1. OFF	▲
2. ON	▼

2 Select the Security TX option.

- To select Security TX OFF, press .
- To select Security TX ON, press .

SECURITY TX	
09. SECURITY TX	▲
10. COVER SHEET	
11. RECOVERY TRANSMIT	▼

4

Temporary Security TX Change

This function allows you to change the Security TX selection for a single transmission.

1 Press the key.

2 Place the original.

- For details on how to place the originals on the glass. (▶ See page 2-8.)

3 Set the scanning conditions. (▶ See pages 2-10 to 2-15.)



4 Press the key to display the COMM. OPTIONS.

1. SECURITY TX	: OFF	▲
2. ECM	: ON	
3. LONG ORIGINAL	: OFF	
4. LINE MONITOR	: OFF	▼

5 To select "1. SECURITY TX," press .

SECURITY TX	
1. OFF	▲
2. ON	▼

6 Select the Security TX option.

- To select Security TX OFF, press .
- To select Security TX ON, press .

7 Specify the remote FAX. (▶ See pages 2-16 to 2-21.)

3. ENTERING VARIOUS FUNCTIONS (Cont.)

Cover Sheet Registration

This function enables the attachment of a cover sheet to the document being transmitted. Prior to selecting this function for the first time, you may wish to prepare a Cover Sheet image (Logo) to be used on the cover sheet. See Step 3 of this procedure.

1 Display the COVER SHEET Menu.

Press: then

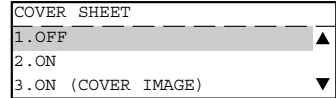

2 Enable or Disable the Cover Sheet.

- To not attach the cover sheet, press .
 - To attach the cover sheet without image, press .
 - To attach the cover sheet with image, press .
- Go to Step 3.

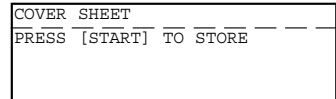

3 Load the image document to be included on the cover sheet and press the key.

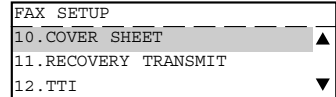

Note

- The image document should be LT (A4) size, and be placed in LT-R (A4-R) orientation.
- In preparing a document for your cover sheet image, only a limited area will be included as shown below. Any data outside the specified range will be disregarded.

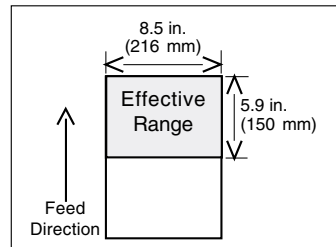
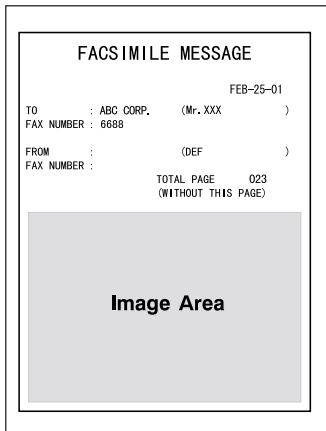

Attaching or Printing Cover Sheet

This function attaches a cover sheet to the document to be transmitted or prints the cover sheet for confirmation purposes.

- When sending multi-address transmissions, the cover sheet will be attached to the document for every address.
- TTI (Transmit Terminal ID) will not be printed on the cover sheet.
- Smart Batch is not available if this function is used.
- When resending a document due to an error, the cover sheet is again attached to the retransmission.
- In Transmission Reports and Journals, the number of pages of each transmission does not include the cover sheet.
- When a Transmission Report is issued with the document image output, the first page data of the facsimile will be printed but not the cover page data.
- The cover sheet is always sent in Letter (A4) size.
- The resolution for the cover sheet is fixed to FINE. However, if the receiving unit is set to STD, the cover sheet is sent in STD.

4

1 Press the  key.



2 Place the original.
• For details on how to place the originals on the glass.
(▶ See page 2-8.)

3 Set the scanning conditions. (▶ See pages 2-10 to 2-15.)

4 Press the  key (on the Function key panel).

COVER SHEET
1. TRANSMIT
2. PRINT

5 Select the option.



- To attach the cover sheet, press .
- To print the cover sheet, press . When printing is completed, the display returns to the Standby Mode.

COVER SHEET
ENTER REMOTE NAME

6 Enter the Remote FAX Name and press the  key.

COVER SHEET
ENTER YOUR NAME

7 Enter your name and press the  key.

ENTER TEL NUMBER (MAX128):
FEB25-2001 11:30AM M :100%
RESOLUTION:STANDARD  :AUTO
COMM.OPTION 

8 Specify the remote FAX. (▶ See pages 2-16 to 2-21.)

3. ENTERING VARIOUS FUNCTIONS (Cont.)

4

Cover Sheet Format

Your Station ID (if preset; max. 40 characters)

Remote Station ID (printed when preset to the Abbreviated Dial Number or One Touch Dial Key used for dialing). Max. 20 characters

FACSIMILE MESSAGE

FEB-25-2001

*** RE-TRANSMISSION ***

TO : ABCDEFGHIJKLMNOPQRST (ABCDEFGHIJKLMNOPQR)

FAX NUMBER : 123456789012345678901234567890

FROM : ABCDEFGHIJKLMNOPQRSTUVWXYZ (ABCDEFGHIJKLMNOPQR)

FAX NUMBER : 12345678901234567890

TOTAL PAGE 001
(WITHOUT THIS PAGE)

- Image Data Area -

(The image here may be your company logo, etc. It can be preset by scanning, using the Cover Sheet Function setting operation on page 4-28. If no image is scanned for this purpose, this area is left blank.)

Cover Page Title (fixed)

Date this document was reserved

Subtitle printed for retransmission only

Remote Name which was entered using this operation

Dialed Facsimile Number (first 38 digits)

Your Name which was entered using this operation

Your Facsimile Number (max. 20 digits)

Number of document pages to be transmitted

Setting Recovery Transmission

Recovery Transmission allows the operator to retransmit a document after failing the initially specified number of redial attempts.



If Recovery Transmission is set to ON, the document is stored in memory for a specified length of time. You may retransmit the document during this time period without rescanning the original document.

1 Displaying the RECOVERY TX Menu.

Press:  then      

RECOVERY TRANSMIT	
1. OFF	▲
2. ON	▼

2 Select the Recovery Transmission option.

- To turn OFF Recovery Transmission, press .
 - To turn ON Recovery Transmission, press .
- Go to Step 3.

RECOVERY TRANSMIT	
STORE	24 HOURS
TIME : 08	◆
	01 HOUR

3 Using the or key, select the stored time length (01 to 24 hours) and press the key.

FAX SETUP	
11. RECOVERY TRANSMIT	▲
12. TTI	
13. SEND AFTER SCAN	▼

3. ENTERING VARIOUS FUNCTIONS (Cont.)

Sending Recovery Transmission

This operation is used to resend a document after the document initially failed to be sent. If recovery transmission is set to ON, the document is stored in this machine for resending.

Note

When Recovery Transmission is set to OFF, an error tone and “RECOVERY TX is off” prompt result when Recovery Transmission is selected.

When Recovery Transmission is set to ON but no documents are in the Recovery Queue, a “No entry” prompt will result.

4

1 Press the  key.

2 Press the  key (on the Function key panel).

12345	▲
650-845-1111	▼
DELETE	▶
	DETAIL

3 Using the  or  key, select the job to be resent.

• Using the  key, you will confirm the detailed information.

SINGLE TRANSMIT	
12345	-----
FEB25-2001 11:30AM	
JOB NUMBER	: XXX

• After confirming it, press the  key, you can also change the number of the remote FAX from the Dial Keypad.

CHANGE TEL NUMBER
 12345

• Using the  key, you can delete the job stored for resending.

DELETE?	
12345	
1. YES	▲
2. NO	▼

• If you want to delete the job, select “1.YES” and press the

 key.

Deleted
12345

4 Press the  key.

TTI (Transmit Terminal ID) Print Setting

To properly identify the sender of your documents, this facsimile prints a transmission header (TTI) on the recording paper of the remote facsimile. The information included in the TTI are:

- Date and Start Time
The date and start time when this document is sent to the remote facsimile.
- Transmitting Station ID Name (▶ see page 4-18.)
- Transmission Serial Number
With each transmission, this facsimile automatically assigns a unique transmission number. This number is also printed on the Activity Journals.
- Page Number/Total Number of Pages
Each page of the document is printed with a page number followed by the total number of pages in the document (e.g. 001/003 means the first page of three total pages).
- File Number
Each document sent from memory is assigned a file number. This file number is used by the facsimile to assist you in managing multiple document jobs.

Important



The U.S. Federal Communication Commission (FCC) requires that anyone sending a facsimile message must identify themselves (or company), give their facsimile telephone number, and provide the date and time of the transmission. This information must be on the lead-edge of, at least, the first page of the facsimile transmission.

1 Displaying the TTI Menu.

Press:  then      

TTI	-----
1. OFF	▲
2. ON	▼

2 Select the Recovery Transmission option.

- To select not to print the TTI, press .
- To select to print the TTI, press .

FAX SETUP	-----
12. TTI	▲
13. SEND AFTER SCAN	
14. ACCOUNT CODE	▼

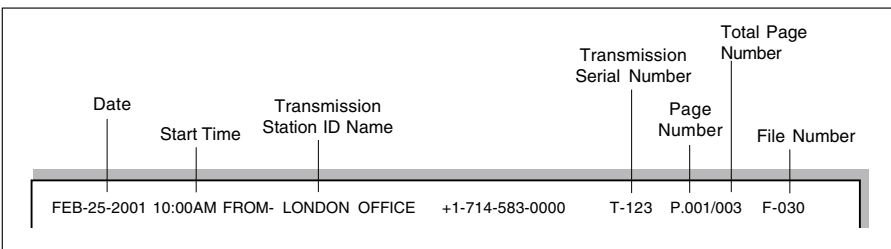

3. ENTERING VARIOUS FUNCTIONS (Cont.)

Send After Scan Default Setting



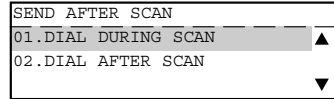

This feature enables you to determine whether dialing starts while the machine is scanning the documents or after the machine has scanned all documents in the Memory Send mode.

1 Displaying the SEND AFTER SCAN Menu.

Press: PROGRAM  then      



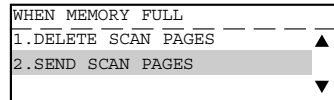

2 Select the Send After Scan option.

- To disable Send After Scan, press  .
- To send the pages after scan, press  . Go to step 3.



3 Select the Memory Full option.

- To delete the pages that have been scanned, press .
- To send the pages already scanned to memory, press .

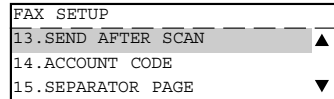

Enabling or Disabling Send After Scan Temporarily

With the Send After Scan Mode Default Setting set to "OFF", this feature allows you enable the Send After Scan mode for a single transmission. Once that transmission is complete, the default status is regained.

With Send After Scan selected, every page of the document will be scanned into memory before dialing will begin.

With Send After Scan set to OFF (NO), your facsimile will begin dialing after the first page is scanned to memory.

1 Press the  key.

2 Place the original.

- For details on how to place the originals on the glass.
(▶ See page 2-8.)

3 Set the scanning conditions. (▶ See pages 2-10 to 2-15.)

4 Press the  key (on the Function key panel).

SEND AFTER SCAN
1. OFF
2. ON

5 Select the SEND AFTER SCAN option.

- To disable Send After Scan, press **1**.
- To enable Send After Scan, press **2**. Go to Step 6.

WHEN MEMORY FULL
1. DELETE SCAN PAGES
2. SEND SCAN PAGES

6 Select the Memory Full option.

- To delete the pages that have been scanned, press **1**.
- To send the pages already scanned, press **2**.

ENTER TEL NUMBER (MAX128):
FEB25-2001 11:30AM M: 100%
RESOLUTION: STANDARD  :AUTO
COMM. OPTION ▼

7 Specify the remote FAX. (▶ See pages 2-16 to 2-21.)

3. ENTERING VARIOUS FUNCTIONS (Cont.)

Account Codes

This feature provides valuable Account Code tracking information for each facsimile transmission sent from the unit.

When a facsimile is transmitted, the account code number will be recorded on the Transmission Journal.

1 Displaying the ACCOUNT CODE Menu.

Press: PROGRAM then 0 1 0 3 1 4

ACCOUNT CODE	
1. OFF	▲
2. ON	▼

2 Select the Account Code function.

- To disable Account Code prompting and printing on the Transmission Journal, press 1.
- To enable Account Code prompting and printing on the Transmission Journal, press 2.

FAX SETUP	
14. ACCOUNT CODE	▲
15. SEPARATOR PAGE	
16. SECURE RX	▼

Account Code Entry

This procedure assumes that you have enabled the Account Code option on page 4-36 of this manual. Once enabled, the facsimile will prompt for an Account Code prior to dialing the remote FAX. The entered Account Code will be printed in the Account Code column on the Activity Journal.

Notes

- Account Code tracking is only possible when using memory communications (Memory Transmission, Polling Receptions, etc.).
- Once entered, an Account Code is only effective for that communication procedure. It will automatically clear upon completion of the communication, upon job cancellation, or upon a communication error.

1 Press the  key.

2 Place the original.
• For details on how to place the originals on the glass.
(▶ See page 2-8.)

3 Set the scanning conditions. (▶ See pages 2-10 to 2-15.)

4 Specify the Remote FAX and press the  key.

ACCOUNT CODE	_____
ENTER ACCOUNT CODE	_____

5 Enter the 4-digit Account Code and press the  key.

SCANNING TO MEMORY	
JOB NUMBER	: 123
SCANNING PAGE	: 001
RESIDUAL MEMORY	: 80%

- It is possible to send a document without entering an Account Code. Simply press the  key a second time.
- The facsimile starts scanning the document into memory. When document scanning is completed, the display returns to the Standby Mode.

3. ENTERING VARIOUS FUNCTIONS (Cont.)

Separator Page Setting

A Separator Page is a sheet automatically inserted between each fax reception. This feature makes it easier to distinguish between individual receptions.

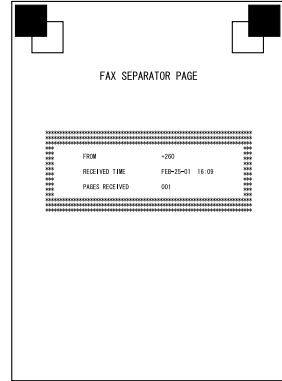
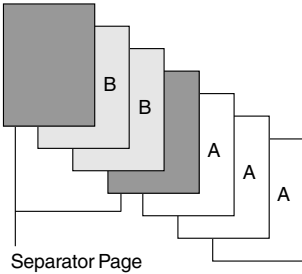

Separator Page

1 Displaying the SEPARATOR PAGE Menu.

Press: ^{PROGRAM} then (0) (1) (0) (3) (1) (5)

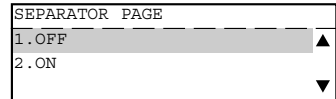

2 Select the facsimile separator page option.

- To turn OFF facsimile separator page, press (1).
- To turn ON facsimile separator page, press (2).

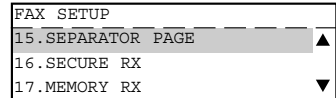

Secure RX Security Code Setting

There are occasions when you may wish to secure access to incoming documents. Secure RX allows you to receive documents to memory until a security code is entered. This ensures that only users with the correct security code may retrieve documents. In addition, the Secure RX can be setup to automatically be activated during a specified time period.

To setup Secure RX, a 4-digit security code must be programmed first. After programming the security code, you can specify the time period during which the Secure RX will be active. 24-hour coverage for specific days of the week is selectable. This section describes the procedure for programming a security code or changing an existing security code.

1 Displaying the SECURE RX Menu.

Press: ^{PROGRAM} then 0 1 0 3 1 6

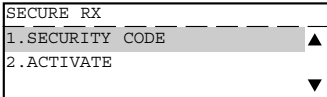

```
SECURE RX
-----
1. SECURITY CODE
2. ACTIVATE
```

2 To select the Security Code for the first time or to change an existing Security Code, press 1.

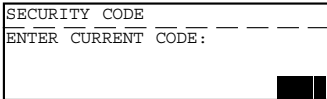

```
SECURITY CODE
-----
ENTER CURRENT CODE:

```

3 New Security Code Setting: Enter a 4-digit password and press the ^{SET} key.

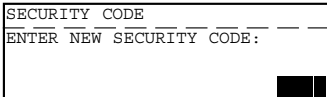

```
SECURITY CODE
-----
ENTER NEW SECURITY CODE:

```

Change an Existing Password:

If the security code already exists, and you wish to change the current password, enter the current password and press the ^{SET} key.

Then enter your new 4-digit password and press the ^{SET} key.

3. ENTERING VARIOUS FUNCTIONS (Cont.)

Secure RX Activation Period Setting

This section describes the procedure to setup this machine to automatically activate Secure RX during a specified time period. Prior to setting this option, you must have a security code set in the facsimile.

Note

If a security code is not set, this machine automatically prompts the security code setting. See the preceding section for details on setting the security code.

4

1 Displaying the SECURE RX Menu.

Press: ^{PROGRAM} then

SECURE RX
1. SECURITY CODE
2. ACTIVATE

2 To select the activity period for Secure RX, press .

SECURE RX
SECURITY CODE:

3 Enter the current security code and press the ^{SET} key.

SECURE RX
1. OFF
2. ON

4 Select to activate automatic Secure RX.

- To deactivate Secure RX, press .
- To activate Secure RX and program the desired coverage periods, press . Go to step 5.

SECURE RX
01. START TIME : 04:00PM
02. END TIME : 09:00AM
03. MONDAY : PERIOD

5 To enter the "START TIME," press .

- Enter the "START TIME" and press the ^{SET} key.

START TIME
TIME : HH:MM
04:00PM
◀ ▶

SECURE RX
01. START TIME : 04:00PM
02. END TIME : 09:00AM
03. MONDAY : PERIOD

6 To enter the “END TIME,” press **0** **2**.

- Enter the “END TIME” and press the **SET** key.

END TIME	
TIME	: HH:MM
	04:00PM
	◀ ▶

SECURE RX	
02.END TIME	: 09:00AM ▲
03.MONDAY	: PERIOD
04.TUESDAY	: PERIOD ▼

7 Set SECURE RX option for each day.

- For example, to select “03.MONDAY,” press **0** **3**.

- To set all day (24-hour) Secure RX for this day, press **1**.
- To set the designated time period, press **2**.

SECURE RX	
1.ALL DAY	▲
2.DESIGNATED TIME PERIOD	▼

SECURE RX	
03.MONDAY	: ALL DAY ▲
04.TUESDAY	: ALL DAY
05.WEDNESDAY	: PERIOD ▼

8 Repeat to set the Secure RX period for each day of the week up to Sunday.

9 Select “10.COMPLETE” when finished by pressing **1** **0**.

3. ENTERING VARIOUS FUNCTIONS (Cont.)

Secure RX Manual Activation

This section describes the procedure to manually activate Secure RX.

Note

In order to manually activate Secure RX, you must first activate Secure RX by going through the Secure RX Security Code setting. (▶ See page 4-39.)

1 Press the  key.

2 Press the  key (on the Function key panel).

Note

If Secure RX Activation is set to OFF in the Secure RX Activation Period Setting, the message “Feature not enabled” will be displayed for 2 seconds, and the screen returns to the Standby Mode.

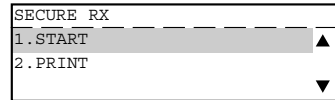

3 To start manual activation, press .

Secure RX Print

This section describes the procedure to manually print out document data received into memory during Secure RX operation.

1 Press the  key.

2 Press the  key (on the Function key panel).



SECURE RX
1. START
2. PRINT

3 Press  to print any documents received into memory during Secure RX.

SECURE RX
SECURITY CODE: _____

4 Enter the 4-digit Security Code and press the  key.

- If there are any received documents in memory, the facsimile will print the documents automatically upon selecting Secure RX Print.
- The Secure RX function will resume once the print out of existing receptions is completed.

ENTER TEL NUMBER (MAX128): _____
Printing
RESOLUTION: STANDARD  : AUTO
COMM. OPTION 

3. ENTERING VARIOUS FUNCTIONS (Cont.)

Reception Reduction Setting

This function allows the reduction of the received image, if the received document is larger than the effective printing area of the recording paper.

1 Displaying the RX REDUCTION Menu.

Press: ^{PROGRAM} then (0) (1) (0) (3) (1) (8)

RX REDUCTION	
1. OFF	▲
2. ON	▼

2 Select the RX Reduction option.

- To set RX Reduction to OFF, press (1).
- To set RX Reduction to ON, press (2).

FAX SETUP	
18. RX REDUCTION	▲
19. DISCARD	
20. PRIVILEGED RX	▼

Reception Discard Setting

This function allows the lower portion of the document to be discarded, if the document is larger than the recording paper.

* To change this dimension, contact your service representative.

1 Displaying the DISCARD Menu.

Press: ^{PROGRAM} then (0) (1) (0) (3) (1) (9)

DISCARD	
1. OFF	▲
2. ON	▼

2 Select the Discard option.

- To set Discard to OFF, press (1).
- To set Discard to ON, press (2).

FAX SETUP	
19. DISCARD	▲
20. PRIVILEGED RX	
21. RTI	▼

Privileged Reception

This function prevents your facsimile from receiving documents from unknown parties. Transmissions to this facsimile are only possible when the sending facsimile's terminal identification or telephone number match those assigned to the Abbreviated Dial Numbers or One Touch Dial Keys on your facsimile.

Notes



- Privileged Reception is effective only on incoming calls received in the Automatic Reception Mode.
- Privileged Reception is not available for polling or mailbox retrieval requests from the remote facsimiles.
- For this feature to work, you must pre-program the numbers of the facsimiles in your communication system into your facsimile's Abbreviated Number or One Touch Dial Key database. In addition, the remote facsimile must have the correct telephone number programmed as its terminal identification.

1 Displaying the PRIVILEGED RX Menu.

Press:  then      

PRIVILEGED RX
1. OFF
2. ON

2 Select the Privileged RX option.

- To turn OFF Privileged Reception, press .
- To turn ON Privileged Reception, press .

FAX SETUP
19. DISCARD
20. PRIVILEGED RX
21. RTI

3. ENTERING VARIOUS FUNCTIONS (Cont.)

RTI (Remote Terminal ID) Print Setting

To clearly identify the time, date, and page count of your facsimile receptions, this facsimile is able to print a Reception Header (RTI) on received documents.

1 Displaying the RTI Menu.

Press: ^{PROGRAM} then (0) (1) (0) (3) (2) (1)

RTI	
1. OFF	▲
2. ON	▼

2 Select the RTI option.

- To not print the RTI, press (1).
- To print the RTI, press (2).

FAX SETUP	
19. DISCARD	▲
20. PRIVILEGED RX	
21. RTI	▼

- LT size or up

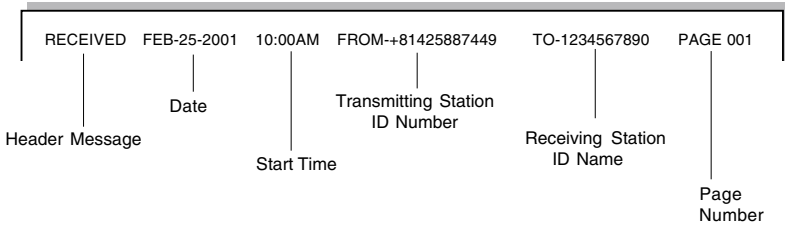

- A5, B5, ST-R

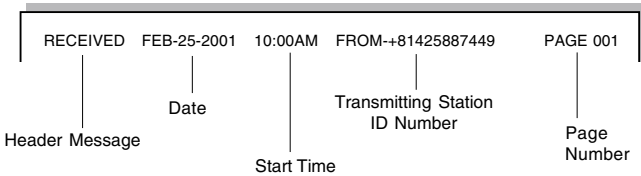

Long Original Setting

When this function is turned on, a long original having a length of up to 1 m can be transmitted.

Tip

- The transmission of a long original is made only up to the length of 70 cm, under the following conditions.
 - <Conditions> This function is turned on and the direct transmission of the long original having the A3 (ledger) width is attempted, to the receiving facsimile machine that is capable of receiving documents with the A4 (letter) width.
- When the transmission of a long original having a length exceeding 1 m is attempted, a paper jam indication will result.
- When the Long original setting is on, transmission in the U-FINE mode is disabled. In this case, transmission is always done in the FINE mode even if U-FINE is selected.

1 Press the  key.

2 Place the original.

- For details on how to place the originals on the ADF or RADF.
(▶ See page 2-8.)

3 Set the scanning conditions. (▶ See pages 2-10 to 2-15.)

4 Press the  key to display the COMM. OPTIONS.

1. SECURITY TX	: OFF	▲
2. ECM	: ON	
3. LONG ORIGINAL	: OFF	
4. LINE MONITOR	: OFF	▼

5 To select “3. LONG ORIGINAL,” press **(3)**.

LONG ORIGINAL		
01. OFF		▲
02. ON		▼

6 Select the Long Original option.

- To disable the Long Original option, press **(1)**.
- To enable the Long Original option, press **(2)**.

ENTER TEL NUMBER (MAX128):			
FEB25-2001	11:30AM	M	:100%
RESOLUTION: STANDARD	Q/D	: AUTO	
COMM. OPTION ▼			

7 Specify the remote FAX. (▶ See pages 2-16 to 2-21.)

3. ENTERING VARIOUS FUNCTIONS (Cont.)

Setting the Page Count

When this function is set to ON, the designated number of pages will be printed at the top of the recording paper at the remote station.

- This setting is available when the originals are loaded into the ADF or RADF but not when the document glass is used.
- It will also assist the recipient to track the number of pages as it will add a page count to the TTI at the top of your transmitted pages (i.e., 001/005, 002/005, 003/005, etc.).
- The facsimile will compare the number of pages actually sent with the number you entered.

4

1 Press the  key.

2 Load the original on the document feeder.

3 Set the scanning conditions. (► See pages 2-10 to 2-15.)

4 Press the  key to display the COMM. OPTIONS.

1. SECURITY TX	:OFF	▲
2. ECM	:ON	
3. LONG ORIGINAL	:OFF	
4. LINE MONITOR	:OFF	▼

5 To select "5. PAGE NUMBER," press .

PAGE NUMBER	_____
PAGE NUMBER (1-999):	_____
	■

6 Enter the number of original pages (1 to 999) and press the  key.

ENTER TEL NUMBER (MAX128):	_____
FEB25-2001 11:30AM M :100%	
RESOLUTION:STANDARD  :AUTO	
COMM.OPTION	▼

7 Specify the remote FAX. (► See pages 2-10 to 2-15.)

Pin Mask

Some telephone PBX (Private Branch Exchange) systems can track and monitor all outgoing calls made by a facsimile. This is done by entering a PIN code after dialing the destination facsimile number.

This facsimile facilitates the telephone PBX system by masking the PIN entered with a "\$" on both the LCD and TX Reports/Journals.

Note

This feature is limited to keypad dialing.
This feature is not available with Abbreviated, Alphabet, or One Touch Key dialing.

1 Press the  key.

2 Place the original.
• For details on how to place the originals on the glass.
(▶ See page 2-8.)

3 Set the scanning conditions. (▶ See pages 2-10 to 2-15.)

4 Enter the number of remote FAX using the Dial keypad.

5 Press the  key (on the Function key panel).

 12345+
FEB25-2001 11:30AM M :100%
RESOLUTION:STANDARD Q/D :AUTO

• A "+" will be displayed on the Message Display.

 12345+\$\$\$
FEB25-2001 11:30AM M :100%
RESOLUTION:STANDARD Q/D :AUTO

6 Enter the Pin Code and press the  key.

• Each charge code number entered is marked with a "\$" displayed on the Message Display.

SCANNING TO MEMORY	
JOB NUMBER	:XXX
SCANNING PAGE	:YYY
RESIDUAL MEMORY	:ZZZ%

3. ENTERING VARIOUS FUNCTIONS (Cont.)

Dialing with Sub-address

This function attaches a sub-address to the standard destination address in the event the remote party requires one.

Three types of sub-addresses can be used (SUB, SEP, and PWD); or any combination of two or three types can be used. After selecting the desired types, the transmission to follow will be sent to the desired address using the designated sub-address.

You can activate this option while programming an Abbreviated Dial Number (▶ See page 2-18.) or One Touch Dial Key (▶ See page 2-21.) if communication with a certain remote party always requires this option.

If you activate this option using both the Abbreviated Dial Number (or One Touch Dial Key) setting and using this procedure for the same destination, this operation will take precedence over the pre-programmed setting in Abbreviated Dial or One Touch Dial.

Sub-Address Communications allow a variety of specialized facsimile communications.

Note

SUB

Sub-Address Transmission

Allows documents to be routed through remote LAN-Fax devices to specific users' workstations.
Allows documents to be transmitted to specific Mailboxes in remote facsimiles.

SEP

Selective Polling

Allows documents to be retrieved from specific Mailboxes residing in remote facsimiles.

PWD

Password

Allows secure communications to SUB and from SEP compatible devices.

Important

If you designate an incorrect sub-address, the communication will result in an error. If you designate an unnecessary sub-address, the communication will result in an error.

1 Press the  key.

2 Place the original.
• For details on how to place the originals on the glass.
(▶ See page 2-8.)

3 Set the scanning conditions. (▶ See pages 2-10 to 2-15.)

4 Press the  key (on the Function key panel).

SUB ADDRESS	
1. COMPLETE	▲
2. SUB ADDRESS (SUB)	
3. SELECTIVE POLLING (SEP)	▼

5 Select one of the following operations from the menu.

- To select SUB, press **2**.
- To select SEP, press **3**.
- To select PWD, press **4**.

SUB ADDRESS
PWD (MAX20) :
1234

6 Enter the required sub-address (max. 20 digits) selected in Step 5 and press the **SET** key.

7 The screen shown in Step 4 is displayed again. Confirm that "1. COMPLETE" is selected, and press the **SET** key.

8 Specify the remote FAX number.
(▶ See pages 2-16 to 2-21.)

4. OUTPUTTING LISTS & REPORTS

List & Report Options Setting

This facsimile allows the operator to set various options regarding the lists and reports listed below.

JOURNAL

There are two types of Journals available on this facsimile. Both the Transmission Journal (TX Journal) and Reception Journal (RX Journal) list the 150 most recent transactions. Journals can be printed either Automatically or Manually. When manually printed, the JOURNAL key must be pressed. To select the type of Journal to print when JOURNAL key is pressed, complete manual Journal printing setting discussed in this section.

COMMUNICATION REPORT

Communication Report allows you to print a report after every transmission. Reports can be printed automatically or manually. When printing automatically, you can designate to print a report for every transmission or only when an error has occurred during the transmission.

In addition, you have the option of printing the first page image of the fax document on the report to facilitate identification.

To setup the Communication Report, go to pages to 4-54 to 4-58.

RECEPTION LIST

This facsimile will print a reception list under the following conditions:

Reservation to Local Mailbox

When reserving a document to a Mailbox within this facsimile locally, a reception list is printed.

Remote Mailbox

When reserving a document to a Mailbox within this facsimile remotely from another facsimile, a reception list is printed at this facsimile.

Relay Station Reception

When this facsimile is setup as a relay hub and receives a relay transmission from an originator, a reception list is printed.

Transmission / Reception Journal Setting

1 Displaying the JOURNAL Menu.

Press: PROGRAM then (0) (1) (0) (6) (0) (1)

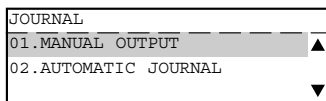

2 Select the desired option.

- To configure the type of Journal to print when the JOURNAL key is used, press (0) (1). Go to Step 3.
- To set automatically printing, press (0) (2). Go to Step 4.

3 Select the manual output option.

- To print both TX and RX Journal, press (1).
- To print only a TX Journal, press (2).
- To print only an RX Journal, press (3).

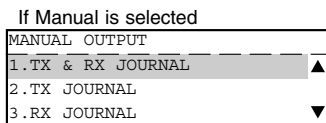

4 Select the automatic journal option.

- To turn OFF Automatic printing of the journal, press (1).
- To turn ON Automatic printing of the journal, press (2).

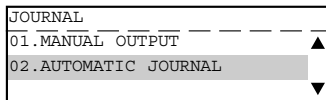
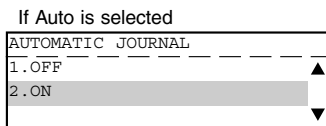

4. OUTPUTTING LISTS & REPORTS (Cont.)

Direct Transmission Report Setting

1 Displaying the TX REPORT Menu.

Press:

PROGRAM
○ then 0 1 0 6 0 2 0 1

TX REPORT	
1. ALWAYS	▲
2. ON ERROR	
3. OFF	▼

2 Select the desired printing option for direct transmission.

- To always print a Transmission Report whenever a document is transmitted, press 1. Go to Step 3.
- To only print a Transmission Report when an error has occurred, press 2. Go to Step 3.
- To turn OFF automatic printing of Transmission Reports, press 3.

A5 SIZE PRINT	
1. OFF	▲
2. ON	▼

3 Select the option for A5 size print.

- To reduce the report size and print on A5 size, press 1.
- To print the report normally, press 2.

COMMUNICATION REPORT	
01. TX REPORT	▲
02. MEMORY-TX REPORT	
03. MULT-ADD REPORT	▼









Note

To print the report on A5 size paper, A5 size paper must be loaded in any cassette.

Memory Transmission Report Setting



1 Displaying the MEMORY-TX REPORT Menu.

Press:

 then        



MEMORY-TX REPORT
1. ALWAYS
2. ON ERROR
3. OFF

2 Select the desired printing option for single location memory transmissions.

- To always print a Transmission Report whenever a document is transmitted, press . Go to Step 3.
- To only print a Transmission Report when an error has occurred, press . Go to Step 3.
- To turn OFF automatic printing of Transmission Reports, press .



PRINT 1st PG IMAGE?
1. OFF
2. ON

3 Select the option for first page image.

- To not print an image of the facsimile document on the Transmission Report, press .
- To print an image of the facsimile document on the Transmission Report, press .

A5 SIZE PRINT
1. OFF
2. ON

4 Select the option for A5 size print.

- To reduce the report size and print on A5 size, press .
- To print the report normally, press .

COMMUNICATION REPORT
02. MEMORY-TX REPORT
03. MULTI-ADD REPORT
04. MULTIPOLL REPORT

4. OUTPUTTING LISTS & REPORTS (Cont.)

Multi-Address Transmission Report Setting

1 Displaying the MULTI-ADD REPORT Menu.

Press:



then 0 1 0 6 0 2 0 3

MULTI-ADD REPORT
1.ALWAYS
2.ON ERROR
3.OFF

2 Select the desired option for Multi-address Transmission Reports.

- To always print a Transmission Report whenever a document is transmitted, press 1. Go to Step 3.
- To only print a Transmission Report when an error has occurred, press 2. Go to Step 3.
- To turn OFF automatic printing of Transmission Reports, press 3.

PRINT 1st PG IMAGE?
1.OFF
2.ON

3 Select the option for first page image.

- To not print an image of the facsimile document on the Transmission Report, press 1.
- To print an image of the facsimile document on the Transmission Report, press 2.

COMMUNICATION REPORT
03.MULTI-ADD REPORT
04.MULTIPOLL REPORT
05.RELAY ORIGINATOR REPORT

Multi-Polling Report Setting

1 Display the MULTIPOLL REPORT Menu.

Press:



then 0 1 0 6 0 2 0 4

MULTIPOLL REPORT
1.ALWAYS
2.ON ERROR
3.OFF

2 Select the desired option for Multi-polling Reports.

- To always print a Report whenever a document is transmitted, press 1.
- To only print a Report when an error has occurred, press 2.
- To turn OFF automatic printing of this Report, press 3.

COMMUNICATION REPORT
04.MULTIPOLL REPORT
05.RELAY ORIGINATOR REPORT
06.RELAY STATION REPORT

Relay Originator Report Setting

1 Displaying the RELAY ORG. REPORT Menu.

Press:

 then **0** **1** **0** **6** **0** **2** **0** **5**

RELAY ORIGINATOR REPORT	
1. ALWAYS	▲
2. ON ERROR	
3. OFF	▼

2 Select the desired option to print a report whenever a Relay transmission is sent.

- To always print a Report whenever a document is transmitted, press **1**. Go to Step 3.
- To only print a Report when an error has occurred, press **2**. Go to Step 3.
- To turn OFF automatic printing of this Report, press **3**.

PRINT 1st PG IMAGE?	
1. OFF	▲
2. ON	
	▼

3 Select the option for first page image.

- To not print an image of the facsimile document on the transmission report, press **1**.
- To print an image of the facsimile document on the transmission report, press **2**.

COMMUNICATION REPORT	
05. RELAY ORIGINATOR REPORT	▲
06. RELAY STATION REPORT	
07. RELAY END REPORT	▼

Relay Station Transmission Report Setting

1 Displaying the RELAY STN. REPORT Menu.

Press:

 then **0** **1** **0** **6** **0** **2** **0** **6**

RELAY STATION REPORT	
1. ALWAYS	▲
2. ON ERROR	
3. OFF	▼

2 Select the desired option to print a report when this facsimile is used as a relay hub station. This report is printed by the hub station to end terminals.

- To always print a Report, press **1**. Go to Step 3.
- To only print a Report when an error has occurred, press **2**. Go to Step 3.
- To turn OFF automatic printing of this Report, press **3**.

PRINT 1st PG IMAGE?	
1. OFF	▲
2. ON	
	▼

3 Select the option for first page image.

- To not print an image of the document, press **1**.
- To print an image of the document, press **2**.

COMMUNICATION REPORT	
05. RELAY ORIGINATOR REPORT	▲
06. RELAY STATION REPORT	
07. RELAY END REPORT	▼

4. OUTPUTTING LISTS & REPORTS (Cont.)

Relay Destination Report Setting

1 Displaying the RELAY END REPORT Menu.

Press:

then 0 1 0 6 0 2 0 7

RELAY END REPORT
1.ALWAYS
2.ON ERROR
3.OFF

2 Select the desired option to send a Relay result report to the Originator terminal when this facsimile is the hub unit used in a relay transmission.

- To always send a report to the Originator, press 1. Go to Step 3.
- To only send a report when an error has occurred, press 2. Go to Step 3.
- To turn OFF Automatic sending of the report, press 3.

PRINT 1st PG IMAGE?
1.OFF
2.ON

3 Select the option for first page image.

- To not send an image of the facsimile document, press 1.
- To send an image of the facsimile document, press 2.

COMMUNICATION REPORT
05.RELAY ORIGINATORS REPORT
06.RELAY STATION REPORT
07.RELAY END REPORT

Reception List Setting

1 Displaying the RECEPTION LIST Menu.

Press: then 0 1 0 6 0 3

RECEPTION LIST
01.LOCAL MAILBOX LIST
02.REMOTE MAILBOX LIST
03.RELAY RECEPTION LIST

2 Select the Job type for Reception List printing.

- To select the Local Mailbox, press 0 1.
- To select the Remote Mailbox, press 0 2.
- To select the Relay, press 0 3.

LOCAL MAILBOX LIST
1.OFF
2.ON

3 Select ON or OFF for the Reception List.

- To select "1.OFF," press 1.
- To select "2.ON," press 2.

RECEPTION LIST
01.LOCAL MAILBOX LIST
02.REMOTE MAILBOX LIST
03.RELAY RECEPTION LIST

List and Report Printing Procedure

Tel List

1 Press the ^{FAX}  key.

2 Press: ^{TEL LIST}  _{PRINT}

TELEPHONE NUMBERS LIST	
1. BY NAME	▲
2. ABB. NUMBERS	
3. GROUP NUMBERS	▼

3 Select a Desired List.

- To print "Alphabetical Sort List," press **1**.
- To print "Abbreviated Number List," press **2**.
- To print "Group Number List," press **3**.
- To print "One Touch Number List," press **4**.
- To print "All List," press **5**.

ENTER TEL NUMBER (MAX128):
Printing list
RESOLUTION: STANDARD  : AUTO
COMM. OPTION ▼

4

Reservation List

1 Press the ^{FAX}  key.

2 Press: ^{RESERVATION}  _{LIST}

ENTER TEL NUMBER (MAX128):
Printing list
RESOLUTION: STANDARD  : AUTO
COMM. OPTION ▼

Department Code List

1 Press: ^{PROGRAM}  then **0** **2** **1**

DEPARTMENT CODE
Printing accepted

4. OUTPUTTING LISTS & REPORTS (Cont.)

Function List

1 Press:  then **0** **2** **2**

FUNCTION

Printing accepted

Mailbox/Relay Box List

1 Press:  then **0** **2** **4**

ITU MAILBOX

Printing accepted

Fax Option List

1 Press the  key.

MENU LIST

Printing accepted

2 Press the  key.

1. SECURITY TX	:OFF	▲
2. ECM	:ON	
3. LONG ORIGINAL	:OFF	
4. LINE MONITOR	:OFF	▼

3 To select "7.MENU LIST," press **7**.

MENU LIST

Printing accepted

Menu List (PROGRAM)

1 Press:  then **0** **4**

MENU LIST

Printing accepted

List and Report Print Format

Transmission/Reception Journal

Transmission/Reception Journals show the result of each communication for up to the past 150 transmissions/receptions.

Auto Print (available if programmed; ► see page 4-53.)

Printing will automatically start whenever 150 transmissions (or 150 receptions) are completed.

Manual Print (always available; ► see page 2-29.)

4. OUTPUTTING LISTS & REPORTS (Cont.)

①

TRANSMISSION JOURNAL

⑨ ⑦ ⑤ ③

⑧ ⑥ ④ ②

PAGE : 001
 TIME : FEB-25-2001 11:48AM
 TEL NUMBER : 12345678901234567890
 E-MAIL : ABCDEFGHIJKLMNOPQRSTUVWXYZ12345678901234
 NAME : ABCDEFGHIJKLMNOPQRSTUVWXYZABCDEFGHIJKLMN
 SCAN COUNT : 67 (00000043)
 PRINT COUNT : 97 (00000061) ⑩
 DRUM COUNT : 970 (000003CA)

NBR	FILE NBR	DATE	TIME	DURATION	PGS	TO	DEPT NBR	ACCOUNT	MODE	STATUS
001	001	FEB-25	12:00AM	00/41	001	12345678901234567890	D 01	9999	◆G3 330	OK 30
002	010	FEB-25	11:10AM	03/47	006	AABBC			EC 503 P	OK
003	011	FEB-25	01:14PM	00/24	000	DDEEPPG	D 08		EX 512 R	NG DO
004	014	FEB-25	11:37PM	10/57	012	◆HHIIJ office	D 20	2000	EC 513	OK
005	028	FEB-26	00:00AM	03/27	003	0559891192			EC 602 SB	NG EO
006	033	FEB-26	11:10AM	01/47	006	CONTENTS dept.			EC 503 I	OK
007	041	FEB-26	11:44AM	00/03	002	SKLLMN			EC 503	OK
008	042	FEB-26	11:44AM	00/06	003	TTUUUV			EX 512	OK
009	043	FEB-26	11:44AM	00/04	001	aabbc			EC 513	OK
010	047	FEB-26	01:21PM	00/14	023	hhiijj			EC 512	OK

⑪ ⑫ ⑬ ⑭ ⑮ ⑯ ⑰ ⑱ ⑲ ⑳

- ① List/report name
- ② No. of pages
- ③ Time of output of the list or report
- ④ Facsimile/telephone number of this machine (Max. 40 characters)
- ⑤ E-mail address of this machine (Max. 40 characters) (I-FAX kit is required)
- ⑥ Your station's ID name (Max, 40 characters)
- ⑦ Scan count (indicates the number of scanned pages.)
- ⑧ Print count (indicates the number of printed pages.)
- ⑨ Drum count (indicates the number of pages that the drum was used for printing)
- ⑩ Machine counter information
- ⑪ Serial No. (lists the transmissions in the order they took place. Indicated in 3 digits (001 ~ 999).)
- ⑫ File No. (assigned to the communication jobs and indicated in 3 digits)
- ⑬ Date and time when communication started
- ⑭ Length of each transmission: Minutes/Seconds (If it takes more than 1 hour, "59/59" is indicated.)
- ⑮ Number of pages (indicated in 3 digits (001 ~ 999). More than 1000 pages is indicated as "999".)
- ⑯ Remote station's name and Fax/telephone number (When an abbreviated dial number or one touch number is used, the remote station's name is indicated.) The mark "◆" indicates an alternate number or sub-address was used.
- ⑰ Department No. (indicates the department responsible for this transmission job; printed only when the department control option is ON)
- ⑱ Account code (indicated in 4 digits when the account number option is ON and used.)

⑩ Mode (The communication mode and added function are indicated.)

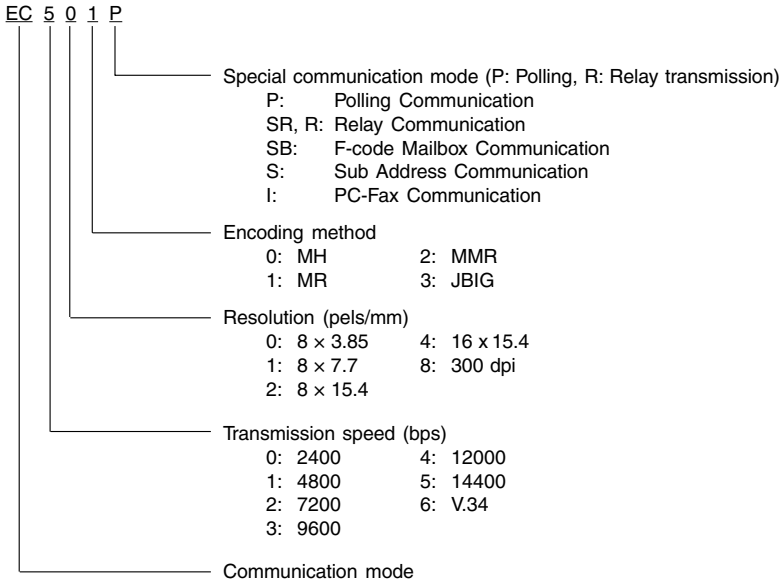

The communication mode is classified as shown below:

Communication Mode	Indication
G3	G3
ECM (*)	EX
ECM	EC
ML	Email
HW, HR	RDC communication

(*): Toshiba shortened protocol version of the original mode is used.

⑪ Result: The result of the transmission is indicated. If the transmission failed, an error code is indicated. When a transmission was completed normally, nothing is indicated.

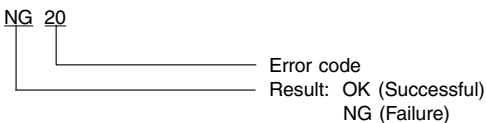

4. OUTPUTTING LISTS & REPORTS (Cont.)

Transmission Report

This is the result report printed after a Direct Transmission (a job transmitted directly from the document feeder instead of from memory).

Auto Print (if programmed; (▶ see page 4-54.)

Printing will automatically start after a transmission is completed.

TRANSMISSION REPORT												
PAGE : 001												
TIME : FEB-25-2001 11:48AM												
TEL. NUMBER : 12345678901234567890												
E-MAIL : ABCDEFGHIJKLMNOPQRSTUVWXYZ12345678901234												
NAME : ABCDEFGHIJKLMNOPQRSTUVWXYZABCDEFGHIJKLMN												
NBR	FILE NBR	DATE	TIME	DURATION	PGS TO	DEPT NBR	ACCOUNT	MODE	STATUS			
004	012	FEB-25	12:00AM	00/32	012	◆ABCDEFGHIJKLMNQRST	D 05	9999	◆BC 503	NG	D0	
ERROR ON PAGES 001 002 003 005												

①

① Error on pages: The page number on which an error occurred is indicated in 3 digits.

* The print format other than “Error on pages” is the same as “Transmission/Reception Journal” on the previous page.

Memory Transmission Report

This is the result report printed after a Memory Transmission. (A job transmitted after the document is first scanned into memory.)

Auto Print (if programmed; (▶ see page 4-55.)

Printing will automatically start after a transmission is completed.

```
MEMORY TRANSMISSION REPORT

PAGE      : 001
TIME      : FEB-25-2001  11:48AM
TEL NUMBER : 12345678901234567890
E-MAIL    : ABCDEFGHIJKLMNOPQRSTUWXYZ12345678901234
NAME      : ABCDEFGHIJKLMNOPQRSTUVWXYZABCDEFGHIJKLMN

① FILE NUMBER      : 999
② DATE            : FEB-25 10:21AM
③ TO              : ABCDEFGHIJKLMNOPQRST
④ DOCUMENT PAGES : 999
⑤ START TIME     : FEB-25 10:00AM
⑥ END TIME       : FEB-25 10:20AM
⑦ SENT PAGES     : 995
⑧ STATUS         : OK

FILE NUMBER      : 004      *** SUCCESSFUL TX NOTICE ***

⑨ ////////////////
  image data
  ////////////////
```

4

- ① File number of the memory transmission job (indicated in 3 digits (001 ~ 999))
- ② Date and time when the memory transmission job was accepted
- ③ Remote party's name or facsimile/telephone number
- ④ Number of pages input in memory
- ⑤ Time when the transmission started
- ⑥ Time when the transmission was completed (When the recovery transmission option is ON, "(RECOVERY TIME: FEB-25 12:48PM)" is added. The data can be resent until the time indicated after "Resend until:" When the transmission is completed normally or the recovery transmission option is OFF, this information is not added.)
- ⑦ Number of pages which were transmitted normally (indicated in 3 digits (001 ~ 999); more than 1000 pages is printed as "999".)
- ⑧ Result: (Result of communication: OK/NG)
- ⑨ The image data on page 1 is reduced and printed.

4. OUTPUTTING LISTS & REPORTS (Cont.)

Multi-Address Transmission Report

This is the result report printed after a Multi-address Transmission.

Auto Print (if programmed; (▶ see page 4-56.)

Printing will automatically start after all transmissions in the operation have been completed successfully or unsuccessfully.

```

MULTI TRANSMISSION REPORT

PAGE          : 001
TIME          : FEB-25-2001  11:48AM
TEL NUMBER    : 12345678901234567890
E-MAIL        : ABCDEFGHIJKLMNOPQRSTU VWXYZ12345678901234
NAME          : ABCDEFGHIJKLMNOPQRSTU VWXYZABCDEFGHIJKLMN

FILE NUMBER   : 999
DATE          : FEB-25  11:31PM
DOCUMENT PAGES : 999
START TIME    : FEB-25  11:10PM
END TIME      : FEB-25  11:32PM (RECOVERY TIME : FEB-26  11:31PM)

SUCCESSFUL

GROUP
0100          SAPPORO_office          ABB.  ◆001  002  *003  004  ◆005  006  *007  008
              OT          009  010  *010  011  012
              OT          02   ◆05   *07  09   *09  11

ONE TOUCH NUMBER
11          ◆ABCDEFGHIJKLMNPQRST
12          SHIZUOKA_office
13 GROUP 0014 NAHA_office          ABB.  *101  102  ◆103
14 ABB.  Z20  OOSAKA_office

SPEED DIAL
014          Amsterdam
015          ◆Naples
016          *New Delhi

TEL NUMBER
-123456789012345678901234567890
123456789012345678901234567890
123456789012345678901234567890
123456789012345678901234567890
1234567
*0120-444444

E-MAIL
*Pushimi_corporation_limited@fu
shimi.co.jp

UNSUCCESSFUL
PAGE SENT
GROUP
0101          Micronesia_office          ABB.  ◆001  123456789012345678901234567890  001
              OT          002  Marshall  002
              OT          02   Seychelles  001

ONE TOUCH NUMBERS
13 Group 0014 NAHA_office          ABB.  104  FUTERNA  001
              *105  TINSUKOJI  001
              106  YONAGUNI  001

51          ◆EASTER EGG
55          SENDAI_office

//////////
document image
//////////
```

4

①

②

③

④

⑤

-
- ① Document pages: The number of pages input in memory is indicated.
 - ② Receivers where the transmission was completed normally. Receiver's name or facsimile/telephone number is indicated.
 - ③ Receiver where an error occurred (indicated when an error occurs) Receivers' name or facsimile/telephone number is indicated.
 - ④ Pages sent: Number of pages sent normally before an error occurred
 - ⑤ The image data on page 1 is reduced and printed.
- * "File Number", "Date", "Start Time", and "End Time" in the format are the same as "Memory Transmission Report".

4. OUTPUTTING LISTS & REPORTS (Cont.)

Multi-Polling Report

This is the result report printed after a Multi-polling Reception.

Auto Print (if programmed; ► see page 4-56.)

Printing will automatically start after all polling operations have been completed successfully or unsuccessfully.

MULTI POLLING REPORT

PAGE : 001
TIME : FEB-25-2001 11:48AM
TEL NUMBER : 12345678901234567890
E-MAIL : ABCDEFGHIJKLMNOPQRSTUVWXYZ12345678901234
NAME : ABCDEFGHIJKLMNOPQRSTUVWXYZABCDEFGHIJKLMN

① FILE NUMBER : 999
② DATE : FEB-25 10:21AM
③ START TIME : FEB-25 10:00AM
④ END TIME : FEB-25 10:20AM

SUCCESSFUL

GROUP

0100 PARIS_office ABB. ◆001 002 003 004 ◆005 006 007 008
OT 02 ◆05 07

ONE TOUCH NUMBER

11 ◆LONDON_office
12 GROUP 0014 12345678901234567890 ABB. 101 102 ◆103
13 ABB. 220 FINLAND_office

SPEED DIAL

014 MOSCOW_office
015 ◆Beijing_office

TEL NUMBER

123456789012345678901234567890
123456789012345678901234567890
123456789012345678901234567890
123456789012345678901234567890
1234567
0120-444-444

UNSUCCESSFUL

GROUP

0101 FAREAST ABB. ◆001 123456789012345678901234567890
002 JAPAN airlines
OT 02 SKYMARK airlines

ONE TOUCH NUMBER

60 ◆SYSTEM DEPT 4F
61 GROUP 1999 TOSHIBATEC ABB. 113 SUZUKI

NOT AVAILABLE

GROUP

0100 PARIS_office ABB. 010 .triumphal arch

ONE TOUCH NUMBER

62 .Caspian Sea

SPEED DIAL

016 .BOSNIA_office

-
- ① File number of the multi-polling job (indicated in 3 digits (001 ~ 999))
 - ② Date and time when the multi-polling job was received
 - ③ Time when the multi-polling reception started
 - ④ Time when the multi-polling reception was completed
 - ⑤ Polling stations where the transmission was completed normally. Station's name or facsimile/telephone number is indicated.
 - ⑥ Polling station where an error occurred (indicated when an error occurs) Station's name or facsimile/telephone number is indicated.

4. OUTPUTTING LISTS & REPORTS (Cont.)

Relay Transmission Originator Report

This is the result report the Originating Terminal prints after initiating a Relay Transmission.

Auto Print (if programmed; ► see page 4-57.)

Printing will automatically start after the originating station transmits the document to the hub station successfully or unsuccessfully.

4

```
RELAY TX ORIG. TERMINAL REPORT
                                     PAGE      : 001
                                     TIME       : FEB-25-2001  11:48AM
                                     TEL NUMBER : 12345678901234567890
                                     E-MAIL    : ABCDEFGHIJKLMNOPQRSTUWXYZ12345678901234
                                     NAME     : ABCDEFGHIJKLMNOPQRSTUWXYZABCDEFGHIJKLMN

① FILE NUMBER      : 999
② DATE            : FEB-25 09:50AM
③ TO              : ABCDEFGHIJKLMNOPQRST
④ RELAY BOX      : 12345678901234567890
⑤ DOCUMENT PAGES : 999
⑥ START TIME     : FEB-25 10:00AM
⑦ END TIME      : FEB-25 10:20AM
⑧ SENT PAGES    : 995
⑨ STATUS        : OK
FILE NUMBER      : 004          *** SEND SUCCESSFUL ***

//////
////// image data
//////
```

⑩

- ① Job number of the relay transmission (indicated in 3 digits (001 ~ 999))
- ② Date and time when the relay transmission was performed
- ③ Relay group's name
- ④ Relay box number
- ⑤ Number of transmitted pages (indicated in 3 digits (001 ~ 999); more than 1000 is indicated as "999".)
- ⑥ Time when the transmission started
- ⑦ Time when the transmission was completed
- ⑧ Number of pages sent normally before an error occurred.
- ⑨ Result: OK/NG
- ⑩ The image data on page 1 is reduced and printed.

Relay Station Report

The list is output on the Relay Station upon receiving a relay request.

Auto Print (if programmed; ► see page 4-58.)

Printing will automatically start upon receiving a request to perform a relay operation.

RELAY STATION REPORT

```
PAGE      : 001
TIME      : FEB-25-2001 10:22AM
TEL NUMBER : 12345678901234567890
E-MAIL    : ABCDEFGHIJKLMNOPQRSTUVWXYZ12345678901234
NAME      : ABCDEFGHIJKLMNOPQRSTUVWXYZABCDEFGHIJKLMN
```

①	FILE NUMBER	:	999
②	DATE	:	FEB-25 10:21PM
③	RELAY BOX	:	12345678901234567890
④	DOCUMENT PAGES	:	999
⑤	FROM	:	+1234567890123456789

- ① File number that the relay station assigns when it accepts the relay request (indicated in 3 digits (001 ~ 999))
- ② Time and date when the relay request is received
- ③ Relay box number
- ④ Number of transmitted pages (indicated in 3 digits (001 ~ 999); more than 1000 is indicated as "999".)
- ⑤ Originator terminal's ID

4. OUTPUTTING LISTS & REPORTS (Cont.)

Relay Transmission Relay Station Report

This is the Relay Station result report, output by the Relay Station and printed after a Relay Transmission.

Auto Print (if programmed; ► see page 4-57.)

Printing will automatically start after the relay station in a relay operation completes all of the transmissions assigned to it, successfully or unsuccessfully.

4

RELAY SEND RELAY STATION REPORT			
		PAGE	: 001
		TIME	: FEB-25-2001 10:23PM
		TEL NUMBER	: 12345678901234567890
		E-MAIL	: ABCDEFGHIJKLMNOPQRSTUVWXYZ12345678901234
		NAME	: ABCDEFGHIJKLMNOPQRSTUVWXYZABCDEFGHIJKLMN
①	FILE NUMBER	:	123
②	DATE	:	FEB-25 09:50PM
③	DOCUMENT PAGES	:	456
④	START TIME	:	FEB-25 10:00PM
⑤	END TIME	:	FEB-25 10:20PM
⑥	RELAY BOX NUMBER	:	12345678901234567890
	SUCCESSFUL		
	GROUP		
	0100	KYUUSYUU	ABB. ◆001 ■002 003 004 ◆005 006 ■007 008
			■009 010 ■010 011 012 ■012
		OT	■02 ◆05 07 ■07 2
	0101	TOUHOKU	ABB. 030 031
	ONE TOUCH NUMBER		
	11	◆ABCDEFGHIJKLMNQRST	
	12	■FUKUSHIMA	
	13	GROUP 0014 SHIKOKU	ABB. 101 ■02 ◆103
	14	ABB. 220 YAMANASHI	
	SPEED DIAL		
	014	IBARAKI	
	015	◆GUNMA	
	016	MIYAGI	
	UNSUCCESSFUL		
			Pages Sent
	GROUP		
	0101	TOHOKU	ABB. ◆011 IWATE 001
			012 AKITA 002
		OT 22	AGMORI 001
	ONE TOUCH NUMBER		
	51	◆HYOUGO	
	55	OKINAWA	
	61	GROUP 1999 CHUUGOKU	ABB. 113 HIROSHIMA 001
			117 TOTTORI 003
			123 SHIMANE 001
⑧			

-
- ① File number of the relay transmission (indicated in 3 digits (001 ~ 999))
 - ② Date and time when the relay transmission was performed
 - ③ Number of transmitted pages (indicated in 3 digits (001 ~ 999); more than 1000 is indicated as “999”.)
 - ④ Time when the relay transmission to the end station started
 - ⑤ Time when the relay transmission to the end station was completed
 - ⑥ Relay box number
 - ⑦ Relay group to which the relay transmission was performed normally.
The abbreviated dial number, one touch number, and multi-address transmission group number, are indicated. (Max. of 100 addresses can be included in the relay box.) When one touch number is used and sub-address dial is used, the mark “◆” is placed. When one touch number or abbreviated dial number in which an E-mail address is registered, is used, the mark “■” is added.
 - ⑧ Relay group to which the relay transmission was not completed normally.
The abbreviated dial number, one touch number, multi-address transmission group number and name, and number of transmitted pages before an error occurred, are indicated.

4. OUTPUTTING LISTS & REPORTS (Cont.)

Relay Transmission Relay End Terminal Report

This is the End Terminal result report sent from the Relay Station to the Originating Terminal and printed by the Originating Terminal.

Auto Print (if programmed; ► see page 4-58.)

Printing will automatically start after the relay station's report on the success or failure of the individual communications in the relay operation.

```

RELAY SEND END STATION REPORT

PAGE          : 001
TIME          : FEB-25-2001  10:23PM
TEL NUMBER    : 12345678901234567890
E-MAIL       : ABCDEFGHIJKLMNOPQRSTUVWXYZ12345678901234
NAME         : ABCDEFGHIJKLMNOPQRSTUVWXYZABCDEFGHIJKLMN

FILE NUMBER   : 123

DATE          : FEB-25  09:50PM

DOCUMENT PAGES : 005

START TIME    : FEB-25  10:00PM

END TIME      : FEB-25  10:22PM

RELAY BOX NUMBER : 12345678901234567890

SUCCESSFUL

GROUP

0100          KYUUSYUU          ABB.  ◆001  ■002  003  004  ◆005  006  ■007  008
           ■009  010  ■010  011
           OT  ■02  ◆05  07  ■07  012  012

0101          TOUHOJKU          ABB.  030  031

ONE TOUCH NUMBER

11          ◆ABCDEFGHIJKLMNQRST
12          FUKUSHIMA
13 GROUP 0014 SHIKOKU          ABB.  101  ■102  ◆103
14 ABB. 220  YAMANASHI

SPEED DIAL

014          IBARAKI
015          ◆GUNMA
016          MIYAGI

UNSUCCESSFUL

GROUP

0101          TOHOKU          ABB.  ◆011  IWATE          001
           012  AKITA          002
           OT  22  ACMORI          001

ONE TOUCH NUMBER

51          ◆HYOGO
55          OKINAWA
61 GROUP 1999 CHUUGOKU          ABB.  113  HIROSHIMA          001
           117  TOTTORI          003
           123  SHIMANE          001
    
```

The format is the same as "Relay Transmission Relay Station Report".

4. OUTPUTTING LISTS & REPORTS (Cont.)

Department Control List

Issues a list of Department Codes and data processed for the Department Control Mode. Available only when the Department Control Mode option is selected. For printing procedure, see page 4-59.

DEPARTMENT CODE LIST

PAGE : 001
TIME : FEB-25-2001 11:48AM
TEL NUMBER : 12345678901234567890
E-MAIL : ABCDEFGHIJKLMNOPQRSTUVWXYZ12345678901234
NAME : ABCDEFGHIJKLMNOPQRSTUVWXYZABCDEFGHIJKLMN

DEPT NBR	NAME	DEPT CODE	COPY PGS	TX PGS	RX PGS	E-MAILS SENT
D 10	DEPARTMENT1	12345	123456	123456	123456	123456
D 20	DEPARTMENT2	60000	2786	3450	26	10890
D 30	DEPARTMENT3	70000	150	250	25	1575

Callout numbers: 1 points to DEPT NBR, 2 to NAME, 3 to DEPT CODE, 4 to COPY PGS, 5 to TX PGS, 6 to RX PGS, 7 to E-MAILS SENT.

- ① Department number (indicated in 2 digits (01 ~ 99) in the ascending order):
- ② Department name (Max. 20 characters)
- ③ Department code (indicated in 5 digits)
- ④ Number of copies (used by each department) : 0 ~ 999999
- ⑤ Number of pages sent (by each department) : 0 ~ 999999
- ⑥ Number of pages received (by each department) : 0 ~ 999999
- ⑦ Number of E-mail messages sent : 0 ~ 999999

Reservation List

This is a listing of the communication jobs now reserved in memory.
For printing procedure, see page 4-59.

	TX/RX	FILE NBR	FUNCTION	PGS	DATE	TIME	TO	
		001	SINGLE TX	001	FEB-24	10:55AM	123456789012345678901234567890	
		002	MULTI TX	011	FEB-24	10:57AM	1234567890 TEL NBR: 1234567890123456789012345678 567-8901	
		008	MULTI POLL		FEB-24	11:08AM	GROUP : abcdefghij.ne.kr 1001 1002 1999	
		010	RELAY ORIGINATOR	003	FEB-24	11:23AM	059891024	
		011	RELAY STATION	003	FEB-24	11:25AM	ABB.NBR: 001 002 003 004 O.T NBR: 01 05 07 07 09 09 11 13 15 17 19 GROUP : 1501 1502	
②	TO BE POLLED	FILE NBR	FUNCTION	PGS	DATE	TIME	TO	
③	RECOVERY TX	POLL/FAX MAILBOX	FUNCTION	PGS	DATE	TIME	TO	
		208	SINGLE TX	004	FEB-24	10:50AM	\$\$\$12-9012-0	
④	PC JOB	FILE NBR	FUNCTION	PGS	DATE	TIME	TO	
		501	PC PRINT	001	FEB-24	11:45AM		
		502	PC SEND	001	FEB-24	11:46AM		
		503	PC RECEIVE	001	FEB-24	11:47AM		
⑤	PROG. CONT. POLL	SECURITY CODE	: 1234					
		INTERVAL	: 10MINUTES					
		START/STOP TIME	: 08:15am-05:10PM					
		START/STOP DAYS	: MON TUE WED THU FRI					
		FAX/OT/ABB/GROUP	: 1234567890123456789012345678901-01-01-01-0					
		O.T NBR:	01 02 03 04 05 06 07 08 09 10					
			008 009 010 011 012 013					
		ABB NBR:	001 002 003 004 005 006 007					
			014 015 016					

4. OUTPUTTING LISTS & REPORTS (Cont.)

- ① Accepted transmission/reception
- ② Polling/Free box
- ③ Items which can be resent.
- ④ Reserved PC print and PC transmission/reception
- ⑤ System polling
- ⑥ Number assigned in the order that the job is accepted (indicated in 3 digit (001 ~ 999))
- ⑦ Job type
- ⑧ Number of pages in the reserved document
- ⑨ Reserved time of calling or Time when the file is to be received
- ⑩ Destination where the reserved job is to be sent

Station's name, facsimile/telephone number, or E-mail address is indicated. Telephone mark (☎) is placed before any keypad entered facsimile/telephone number.

4. OUTPUTTING LISTS & REPORTS (Cont.)

Abbreviated Dial Number List

Issues a list of remote station dialing numbers assigned as Abbreviated Dial Numbers. For printing procedure, see page 4-59.)

ABBREVIATED TEL NUMBER LIST								
ABB. NBR	NAME	TEL NUMBER/E-MAIL ADDRESS	TIME	MONI	BPS	REPORT	MAILMODE	ATT
001	ABCDEFGHIJKLNPQRST	123456789012345678901234567890 1234567 ◆3456789012345678901234567890 123456789012345678901234567890 123456789012345678901234567890 123456789012345678901234567890 1234567 SUB:12345678901234567890 SEP:12345678901234567890 PWD:***** ABCDEFGHIJKLNPQRSTUWXYZABCD ABCDEFGHIJKLNPQRSTUWXYZABCD ABCDEFGHIJKLNPQRSTUWXYZABCD ABCDEFGHIJKLNPQRSTUWXYZ 0559123456	11:45AM	ON	48	ON	200x200 NH	15
002	GREENVILLE OFFICE		12:34PM		ON		200x400 JB	

- ① Abbreviated dial number (indicated in ascending order (001 ~ 999))
- ② Station's name (left-aligned and indicated in a max. of 20 digits)
- ③ Facsimile/telephone number (indicated in a max of 128 digits)
A sub-address dial is indicated on the next line. (The mark "◆" is added before the facsimile/telephone number.) If SUB/SEP/PWD is registered for the facsimile/telephone number, "SUB:", "SEP:", or "PWD:" is added in the front of each line. (Each item has a max. of 20 digits.) The characters of the registered password are indicated by "*****".
- ④ Designated time of transmission by the timer
When there is not a specified time, it is not indicated. (The specified times for the line and E-mail are indicated.)
- ⑤ Line monitoring for each communication (indicated as a communication added function):
ON/OFF
When line monitoring is OFF, nothing is indicated.

Transmission speed	Indication
144000 bps	144
9600 bps	96
4800 bps	48
Not specified	Blank

-
- ⑥ Transmission speed
 - ⑦ Report (indicated as a communication added function): ON/OFF
The settings for the line and E-mail are indicated.
 - ⑧ Mail mode
The resolution and encoding method set for the E-mail address, are indicated.
 - ⑨ ATT level (indicated only when the test mode is selected).
In a mode other than test mode, the ATT level, including its title, is not indicated.

4. OUTPUTTING LISTS & REPORTS (Cont.)

Group Number List

Issues a list of One Touch Key or Abbreviated Dial Numbers registered in Multi-address Groups or Multi-polling Groups.
For printing procedure, see page 4-59.)

GROUP NUMBER INFORMATION			
		PAGE	: 001
		TIME	: FEB-25-2001 11:48AM
		TEL NUMBER	: 12345678901234567890
		E-MAIL	: ABCDEFGHIJKLMNOPQRSTUVMXYZ12345678901234
		NAME	: ABCDEFGHIJKLMNOPQRSTUVWXYZABCDEFGHIJKLMN
②	GROUP NUMBER	NAME	OT/ABB. NUMBER
	0001	ABCDEFGHIJKLMNQRST	OT •001 ABCDEFGHIJKLMNQRST 002 AABCCDD 003 EEEFGG •004 HHII
			ABB. 111 ABCDEFGHIJKLMNQRST 112 JJKLLMM •113 NNOOPP 114 QQRR 011 SSTTUUVV •011 SSTTUUVV
	1234	COMPANY_GROUP	012 WXXYY •012 WXXYY 013 ZZ ABB. •121 aabccdd 122 eeffgg •122 eeffgg
			③ ④ ⑤

- ① Group number (indicated in 4 digits in the ascending order)
- ② Group name (indicated in max. 20 characters)
- ③ Type: One touch number/Abbreviated dial number
- ④ One touch number/Abbreviated dial number (indicated in ascending order)
- ⑤ Station's name

4. OUTPUTTING LISTS & REPORTS (Cont.)

Function List

Issues a list to confirm the functions currently set in this facsimile unit.
For printing procedure, see page 4-60.

```

ROMVersion001 ROMVersion002
ROMVersion003 ROMVersion004

FUNCTION LIST

PAGE          : 001
TIME          : FEB-25-2001 11:48AM
TEL. NUMBER   : 12345678901234567890
E-MAIL        : ABCDEFGHIJKLMNOPQRSTUUVWXYZ12345678901234
NAME          : ABCDEFGHIJKLMNOPQRSTUUVWXYZABCDEFHIJKLMN

CALL NUMBER   :
KEYBOARD TYPE : QWERTY
AVAILABLE MEMORY : 96MB

MACHINE DEFAULTS
CASSETTE SIZE
CASSETTE1     : A4
CASSETTE2     : A3
CASSETTE3     : A5
(CASSETTE4    : A4 )
BYPASS        : A4
WALKUP SCREEN : COPY
TIMERS
  AUTO CLEAR   : 45SEC
  AUTO LOW POWER : 60SEC
  AUTO SLEEP   : 4MIN
WEEKLY TIMER  : OFF
SPEAKER VOLUME
  ALARM VOLUME : 7
  KEY TOUCH VOLUME : 7
  RINGER VOLUME : 7
  MONITOR VOLUME : 7

COPY SETUP
APS/AMS      : APS
IMAGE MODE   : TEXT/PHOTO
LIGHT/DARK   : AUTO
FINISHING    : NON SORT

FAX SETUP
LINE MONITOR : ALWAYS
RECEIVE INTERVAL : 3MIN
ECM          : OFF
DOCUMENT MODE : STANDARD
  LIGHT/DARK : MANUAL
DIAL TYPE    : FSTN
REDIAL MODE
  INTERVAL    : 1MIN
  COUNTER     : 02
  AUTO RECEIVE MODE : AUTO
  RING DELAY  : 1
MEMORY TX    : ON
SECURITY TX  : OFF
COVER SHEET : ON
RECOVERY TX  : OFF
  STORED TIME : 24HOUR
TTI          : OFF
SEND AFTER SCAN : ON
ACCOUNT CODE : OFF
SEPARATOR PAGE : OFF

SECURE RX    : ON
START TIME   : 06:00PM
END TIME     : 09:00AM
SCHEDULE     : SUN SAT
MEMORY RX    : ON
RX REDUCTION : ON
DISCARD      : ON
PRIVILEGED RX : OFF
RTI          : ON

REPORTS & LIST
JOURNAL
  MANUAL OUTPUT : TX & RX
  AUTO          : ON
COMMUNICATION REPORT
DOCUMENT TX     : ALWAYS
MEMORY TX      : ALWAYS (IMAGE)
MULTI TX       : ALWAYS (IMAGE)
MULTI POLL     : ON ERROR
RELAY ORIGINATOR : ALWAYS (IMAGE)
RELAY STATION  : ALWAYS (IMAGE)
RELAY DESTINATION : ALWAYS (IMAGE)
RECEPTION LIST
LOCAL MAILBOX  : ON
REMOTE MAILBOX : OFF
RELAY STATION  : ON

REMOTE SERVICE
REMOTE ACCESS  : OFF
DOWNLOAD FIRMWARE : NO JOB
RDC PASSWORD   :

TOTAL PAGE
SCAN           : 1394
PRINT          : 67277
    
```

Fax Option List

Issues a list of menu items through which functions or options can be set. This list can be a useful guide during machine programming. For printing procedure, see page 4-60.

FAX OPTION LIST

PAGE : 001
TIME : FEB-25-2001 11:48AM
TEL NUMBER : 12345678901234567890
E-MAIL : ABCDEFGHIJKLMNOPQRSTUVWXYZ12345678901234
NAME : ABCDEFGHIJKLMNOPQRSTUVWXYZABCDEFGHIJKLMN

FUNCTION KEYS

01.CHAIN DIAL COMM
02.CHARGE CODE
03.DELAYED COMM
04.DIRECT TX
05.LOW SPEED TX
06.IIU MAILBOX
07.COVER SHEET
08.PRIORITY TX
09.MULTI
10.RECOVERY TX
11.SEND AFTER SCAN
12.POLLING
13.SUB ADDRESS COMM
14.JOB STATUS
15.JOURNAL
16.PREV.TX RPT.
17.RESERVATION LIST
18.SECURE RX
19.CHECK E-MAIL
20.TX REPORT
21.TEL LIST ENTRY
22.TEL LIST PRINT

COMM. OPTIONS

01.SECURITY TX
02.ECM
03.LONG ORIGINAL
04.LINE MONITOR
05.PAGE NUMBER
06.DUPLEX SENDING
07.MENU LIST

4. OUTPUTTING LISTS & REPORTS (Cont.)

Menu List (PROGRAM)

Issues a list of menu items through which functions or options can be set. This list can be a useful guide during machine programming. For printing procedure, see page 4-60.

MENU LIST (PROGRAM)

PAGE : 001
TIME : FEB-25-2001 11:48AM
TEL NUMBER : 12345678901234567890
E-MAIL : ABCDEFGHIJKLMNOPQRSTUWXYZ12345678901234
NAME : ABCDEFGHIJKLMNOPQRSTUWXYZABCDEFHIJKLMN

01.DEFAULT SETTINGS
01.MACHINE DEFAULTS
01.CASSETTE SIZE
02.WALKUP SCREEN
03.TIMERS
04.WEEKLY TIMER
05.SPEAKER VOLUME
06.DEPARTMENT CODE
02.COPY SETUP
01.APS/AMS
02.IMAGE MODE
03.LIGHT/DARK
04.FINISHING
03.FAX SETUP
01.LINE MONITOR
02.RECEIVE INTERVAL
03.ECM
04.DOCUMENT MODE
05.DIAL TYPE
06.REDIAL MODE
07.AUTO RECEIVE MODE
08.MEMORY TX
09.SECURITY TX
10.COVER SHEET
11.RECOVERY TRANSMIT
12.TTI
13.SEND AFTER SCAN
14.ACCOUNT CODE
15.SEPARATOR PAGE
16.SECURE RX
17.MEMORY RX
18.RX REDUCTION
19.DISCARD
20.PRIVILEGED RX
21.RTI

04.E-MAIL SETUP
05.SCAN SETUP
06.REPORT & LIST
01.JOURNAL
01.MANUAL OUTPUT
02.AUTOMATIC JOURNAL
02.COMMUNICATION REPORT
01.TX REPORT
02.MEMORY-TX REPORT
03.MULTI-ADD REPORT
04.MULTIPOLL REPORT
05.RELAY ORIGINATOR REPORT
06.RELAY STATION REPORT
07.RELAY END REPORT
03.RECEPTION LIST
01.LOCAL MAILBOX LIST
02.REMOTE MAILBOX LIST
03.RELAY RECEPTION LIST
07.REMOTE SERVICE
01.REMOTE ACCESS
02.DOWNLOAD FIRMWARE
03.RDC PASSWORD
04.SUPPLY ORDER
02.LISTS
1.DEPARTMENT CODE
2.FUNCTION
3.SUPPLY ORDER
4.ITU MAILBOX

MENU LIST (PROGRAM)

PAGE : 002
TIME : FEB-25-2001 11:48AM
TEL NUMBER : 12345678901234567890
E-MAIL : ABCDEFGHIJKLMNOPQRSTUWXYZ12345678901234
NAME : ABCDEFGHIJKLMNOPQRSTUWXYZABCDEFHIJKLMN

03.INITIAL SETUP
01.DATE & TIME
01.SETTING
02.TIME FORMAT
03.DATE MODE
04.MONTH MODE
02.LANGUAGE
03.TERMINAL ID
04.NETWORK
04.MENU LIST
05.TEST MODE
01.AUTO TEST
02.INDIVIDUAL TEST
01.ADF TEST
02.KEY TEST
03.LED TEST
04.LCD TEST
05.SPEAKER TEST
06.SWITCH TEST
07.TEST PRINT
03.TEST RESULT LIST
06.TOTAL PRINT COUNTER
07.MACHINE REVISIONS

Power Failure List

This facsimile has a battery to back up the document memory contents. However, when the power is turned off for a lengthy period (due to a power failure, etc.) and the communication data stored in memory is cleared, a list of the File Numbers of those cleared communications will be printed.

This list is automatically printed after recovery from a power failure.

POWER FAILURE LIST				
		PAGE	:	001
		TIME	:	FEB-25-2001 11:48AM
		TEL NUMBER	:	12345678901234567890
		E-MAIL	:	ABCDEFGHIJKLMNQRSTUWXYZ12345678901234
		NAME	:	ABCDEFGHIJKLMNQRSTUWXYZABCDEFGHIJKLMN
①	TX/RX	FILE NBR TYPE		

		001 MULTI TX		
		003 POLLING RX		
		008 MULTI POLLING		
		009 E-MAIL TO FAX GTWY		
		010 OFFRAMP GATEWAY		
		011 RELAY ORIGINATOR		
		012 RELAY STATION		
②	POLL/FAX M-BOX/MAILBOX	FILE NBR TYPE	MAIL	FROM
		-----		DATE TIME
		106 CONFIDENTIAL BOX	12345678901234567890	0559891014
		107 BULLETIN BOARD	12345678901234567890	LOCAL
		108 COVERSHEET	LOCAL	FEB-24 11:23AM
				FEB-25 08:27AM
③	MEMORY RECEPTION	FILE NBR TYPE	FROM	DATE TIME

		201	12345678901234567890	FEB-23 04:11PM
④	RECOVERY TX	FILE NBR TYPE		

		301 SINGLE TX		
⑤	PC JOB	FILE NBR TYPE		

		401 PC PRINT		
		402 PC SEND		
		403 PC RECEIVE		

① Send/Receive

- The reserved transmission and the reception from the relay station are indicated.

② Poll box/Free box/Mail box (indicates that data exists)

③ Receive to memory (indicates that data received normally exists)

④ Resend stored fax (indicates that data to be resent exists)

⑤ PC Job (indicates that data to be printed/sent/received exists)

⑥ Job number (assigned when communication was made)

⑦ Type of communication job

⑧ Mail box number

⑨ Station from which the data was input: Local or Facsimile/Telephone number (if provide by the remote device)

⑩ Time when the data was input into data memory.



TROUBLESHOOTING

1. TROUBLESHOOTING	5-3
When the Graphic Symbols Flash	5-3
Error Message	5-4
Transmission Trouble	5-6
Reception Trouble	5-7
Error Codes Printed on Reports	5-8



1. TROUBLESHOOTING

When the Graphic Symbols Flash

Graphic symbols for indicating the state of the copier appear on the display. When a graphic symbol flashes, remedy the trouble referring to “When the Graphic Symbols Flash” in the Operator’s Manual (for Copying Function).

1. TROUBLESHOOTING (Cont.)







Error Message

When an abnormality occurs inside the copier or the copier is operated improperly, an error message is displayed on the LCD. Take the appropriate action by referring to the following chart.

For error messages that are not described below, refer to the Copying Function in the Operator's Manual.

Note





When the message "Misfeed in xxxx", "CASSETTE xx empty", "LCF empty", "Add paper", "Toner empty", or "Replace process unit" is displayed, memory reception may be performed. Clear the message without turning off the power.

Error Message	Cause	Solution
Broken registration	Auto dialer numbers and initial setting have been lost (due to a lengthy power failure, depleted battery, etc.)	Press <small>CLEAR/STOP</small>  to restore the idle state. If this Error Message is repeatedly displayed, machine programming has become corrupted. The machine must be reinitialized by a trained technician. Call for service.
Line busy	A direct transmission was made to a remote fax that was busy.	Press <small>FUNCTION CLEAR</small>  to restore the idle state. Retry the transmission.
Communication error	A communication error occurred during a transmission.	Press <small>FUNCTION CLEAR</small>  to restore the idle state. Retry the transmission.
Feature unavailable	<ul style="list-style-type: none"> Communication error resulting from a security code disagreement during a MAILBOX transmission. Communication error resulting from a telephone number conflict during a security transmission. 	Press <small>FUNCTION CLEAR</small>  to restore the idle state. Confirm the security code or telephone number, and then retry the transmission.
Power failure	Reserved jobs or received image data were erased due to a lengthy power failure.	Press <small>FUNCTION CLEAR</small>  to restore the idle state. Check the POWER FAILURE LIST that was output for information on any lost communication.
Memory is full	The memory became full during data entry into memory during a transmission or reception.	Press <small>FUNCTION CLEAR</small>  to restore the idle state. <Memory full during transmission> Wait for the memory to become available and then retry memory transmission, or perform a direct transmission. <Memory full during reception> Contact the other party to re-transmit the document.

Error Message	Cause	Solution
Page number mismatch	The designated number of pages did not agree with the number of pages actually scanned, in transmission.	Press <small>FUNCTION CLEAR</small>  to restore the idle state. Confirm the number of pages of the original.
Add paper	Recording paper has run out in all cassettes, or all cassettes are removed.	Load recording paper, or insert the cassette firmly. Memory reception may be performed. Do not turn off the power.
CASSETTE 1 empty CASSETTE 2 empty CASSETTE 3 empty CASSETTE 4 empty LCF empty	Paper has run out in the designated cassette, or the cassette is removed.	Load recording paper, or insert the cassette firmly. Memory reception may be performed. Do not turn off the power.
Misfeed in xxxx	A recording paper jam has occurred.	Remove the jammed paper. (Refer to the operator's manual for copying function.) Memory reception may be performed. Do not turn off the power.
Toner empty	The toner is exhausted.	Replace the toner. (Refer to the Operator's manual for copying function.) Memory reception may be performed. Do not turn off the power.
Replace process unit	The process unit has reached the end of its life.	Replace the process unit. (Refer to the Operator's manual for copying function.) Memory reception may be performed. Do not turn off the power.

Transmission Trouble

Check the following points if you are having trouble sending originals. If you cannot rectify the trouble by checking these points, or trouble not listed below occurs, contact your service representative.



Trouble	Check Point
<p>“DIALING” or “COMMUNICATING” is not displayed even if the  key is pressed in Direct Transmission Mode.</p>	<ul style="list-style-type: none"> • Did you press the  key before beginning the Direct TX operation? • Did you replace the handset before you pressed the  key? <p>When you are making a call using a handset to send a FAX, do not replace the handset until after you press the  key and you hear the phone line switch to the machine.</p> <ul style="list-style-type: none"> • Is the modular cord disconnected? • Is the dial type set correctly? • Can you receive telephone calls? • Is there any problem at the remote fax? Check this with the party trying receive the original.
<p>Originals are fed diagonally (skewed).</p>	<ul style="list-style-type: none"> • Are the slides adjusted to the width of the original that you are sending? • Does the original meet the conditions established for use with this device? (See page 2-4 of the Operator's manual for Copying function.)
<p>Two originals are fed together.</p>	<ul style="list-style-type: none"> • Have you placed more than 50 sheets of Letter (A4-size) paper on the ADF or 100 sheets of Letter (A4-size) paper on the RADF? (50 or 100 is the maximum number of originals that can be placed at one time.) • Does the original meet the conditions established for use with this device? (See page 2-4 “Originals” of the operator's manual for Copying function.) • Have you pushed in the originals too hard?
<p>The original is not being printed on the paper of the remote FAX even though it is being sent.</p>	<ul style="list-style-type: none"> • Is the original placed facing the correct way?
<p>Originals are not sent even if operations are carried out normally.</p>	<ul style="list-style-type: none"> • Is the remote FAX compatible with your copier? • This copier supports G3 communications but not G4 communications.
<p>Cannot send overseas</p>	<p>Specify Low Speed TX and resend. (▶ See page 3-6.)</p>

1. TROUBLESHOOTING (Cont.)

Reception Trouble

Check the following points if you are having trouble receiving originals.

If you cannot rectify the trouble by checking these points, or trouble not listed below occurs, contact your service representative.

Trouble	Check Point
Originals cannot be received even if the  key is pressed.	<ul style="list-style-type: none"> • Did you wait for the bell to ring before you picked up the handset? • Did you replace the handset before you pressed the  key? <p>When you answer a call using the handset to receive a FAX, do not replace the handset until you press the  key and you hear the phone line switch to the machine.</p> <ul style="list-style-type: none"> • Is the modular cord disconnected? • Is the power plug unplugged from the power outlet? • Is there a problem at the remote fax? <p>Check this with the party trying to send the original.</p>
Paper is not output.	<ul style="list-style-type: none"> • Is the copier out of paper? • Has a "Misfeed in copier" occurred?
The "Cassette Empty" message does not disappear even if the copier is filled with paper.	<ul style="list-style-type: none"> • Is paper loaded correctly?
The received original is printed dark and is illegible or black stripes are printed on the original.	<ul style="list-style-type: none"> • Is the original being sent a dirty copy? <p>Check this with the party trying to send the original.</p> <ul style="list-style-type: none"> • Is the trouble due to a problem or operator error at the remote FAX? (ex. dirty scan glass or dirty scan lamp) <p>Check this with the party trying to send the original.</p> <ul style="list-style-type: none"> • Does the same problem occur even if you make a copy on your copier? If so, clean the recording unit of your copier.
Paper is output but not printed.	<ul style="list-style-type: none"> • Is there enough toner? • Is the original placed correctly on the remote FAX? <p>Check this with the party trying to send the original.</p>
Paper often jams.	<ul style="list-style-type: none"> • Is the paper cassette size setting correct? • Is the paper cassette properly inserted? • Is the specified paper type being use?

Error Codes Printed on Reports

When an Error Code is printed as the status indication on Transmission Reports, etc., refer to the following description for the applicable Error Code to determine the cause.

Error Code	Cause	How to Correct
10	Paper Empty	Load recording paper and set the paper cassette.
11	Recording paper Jam	Remove the Jammed recording paper.
12	Document paper Jam	Remove the Jammed document.
13	A cover was opened.	Close the cover, then retry.
20	Power Failure	Retry the transmission or ask the remote party to transmit the document again.
21	Error relating to the printer or memory.	Remove the cause of the error or the printer, if any. Then ask the remote party to retry the transmission. If not corrected, call your service representative.
30	<small>CLEAR/STOP</small>  was pressed during the communication.	Retry the transmission or ask the remote party to transmit the document again.
32	Page # Mismatch	Check the actual document count.
33	Polling Error	Check polling options setup (security code, etc.), and check if the polling document exists.
42	During a memory transmission or a memory reception, the machine ran out of image memory. The machine's image memory was exhausted.	Divide the originals into several transmissions for memory transmission. For a memory reception, remove the cause of the error, then ask the remote party to retransmit the document.
50	Line Busy	Confirm the telephone number and then send the document again.
53	Security mismatch in Relay or Mailbox transmission.	Confirm the remote party's security code, system password, and your setup.
80	Signal Error or Line Condition Error	Retry the communication. Frequent failures may indicate a phone line problem. If possible, move the unit to another line and try your communications again.
82		
83		
85		
86		

REMOTE SERVICE

1. RDC (Remote Diagnosis Configuration) Service	6-3
2. AUTOMATIC SUPPLIES ORDER	6-4
Automatic Supplies Order Setting	6-4



6

6-2

1. RDC (Remote Diagnosis Configuration) Service

This machine has a function to receive the following services remotely. (Consult your authorized TOSHIBA dealer for assistance in using this function.)

RDC (Remote Diagnosis Configuration)

This service enables the machine to be dialed from a service center to retrieve information and reports, set various machine settings, program data, and upgrading the firmware in the machine. A separate contract with the service center will be required to receive this RDC service.

Notes

- This capability is currently under development and is not yet available. This RDC Service will be restricted to TOSHIBA trained technicians working for TOSHIBA authorized dealers and will not be available in all areas.
- This function is not available in the United States.

2. AUTOMATIC SUPPLIES ORDER

Automatic Supplies Order Setting

This machine can automatically send an order sheet to a designated fax machine informing your supplier that a replacement Drum Kit or Toner Kit is required.

Contact your local authorized dealer for information on this setting.

Note

This function is not available in the United States.

SPECIFICATIONS

1. SPECIFICATIONS 7-3



7

1. SPECIFICATIONS

Item	Description
Model No.	GD-1060 (For DP1600/2000/2500)
Original Size	LD, LG, LT, ST, COMP, A3, A4, A5-R, B4, B5, FOLIO
Recording Paper Size	11"x17" (LD), 8.5"x14" (LG), 8.5"x11" (LT), 5.5"x8.5" (ST), 10.1/8"x14" (COMP) 297 mm x 420 mm (A3), 210 mm x 297 mm (A4), 148 mm x 210 mm (A5), 257 mm x 364 mm (B4), 182 mm x 257 mm (B5), 210 mm x 330 mm (FOLIO)
Paper Cassette Capacity	550 sheets
Compatibility Communication Mode	ECM, G3, Exclusive Modes: (EX)
Scanning Density	Horizontal: 8 dots/mm, 16 dots/mm Vertical: 3.85 lines/mm, 7.7 lines/mm, 15.4 lines/mm
Transmission Rate	33600/31200/28800/26400/24000/21600/19200/16800/14400/12000/ 9600/7200/4800/2400 bps
Encoding System	JBIG/MMR/MR/MH
Recording and Printing Method	Electrophotography and Laser Printing
Memory Capacity	5.7 MB
Machine Type	Desktop type with both transmission and reception functions
Applicable Network	PSTN (Public Switched Telephone Network)

- Outer appearance, Specifications, etc. may be changed without prior notice.
- If any trouble is encountered, contact your authorized TOSHIBA facsimile dealer.
- The clock function and programming data of this device are preserved with a built-in battery. If the power supply is cut off over a long time, the battery may become discharged, causing the recorded data to be lost.
- Document image data received by this device is preserved with a built-in battery (for about 2 hours.) If the power supply is cut off for a long time, the received data may be lost.



7

INDEX

INDEX

A

- Abbreviated Dial Number List 4-80
- Abbreviated Dialing 2-18
- ABOUT ORIGINALS 2-6
- Account Code Entry 4-37
- Account Codes 4-36
- Alphabet Dialing 2-19
- Alphabetical Sort List 4-79
- Attaching or Printing Cover Sheet 4-29
- AUTO RECEIVE MODE 2-33
- Automatic Image Density Mode
 - Setting Procedure 2-12
- AUTOMATIC SUPPLIES ORDER 6-4
- Automatic Supplies Order Setting 6-4

C

- Canceling Direct Transmission 2-32
- Canceling Memory Transmissions
 - (during transmission) 2-31
- Canceling Reserved
 - Memory Transmissions 2-31
- CANCELING TRANSMISSIONS 2-31
- Canceling transmissions
 - (during scanning) 2-31
- CHAIN DIALING 3-31
- Checking Reserved Transmissions by
 - Printing Reports 2-30
- CHECKING TRANSMISSION RESULTS 2-28
- Checking Transmission Results by
 - Printing Reports 2-29
- Checking Transmission Results on
 - the Message Display 2-28
- Clear the Settings of
 - the Continuous Polling 3-30
- CONNECTING THE CABLES 1-7
- Continuous Polling 3-28
- Correct Entered Characters 4-6
- Correcting Groups
 - (Delete the Remote Station) 4-16
- Correcting Groups
 - (Modify the Remote Station) 4-14
- Cover Sheet Registration 4-28

D

- Default Setting for Document Mode 4-24
- Default Setting for
 - Memory Transmission 4-26
- DELAYED COMMUNICATION
 - (TIME DESIGNATION) 3-3
- Deleting a Relay Box 3-21
- Deleting an Open Mailbox 3-11
- Deleting Documents in a Mailbox
 - (Local Hub) 3-16
- Deleting Groups 4-17
- Department Code List 4-59
- Department Control List 4-76
- DESCRIPTION OF
 - THE CONTROL PANEL 1-8
- DESCRIPTION OF THE OPTIONAL
 - EQUIPMENT 1-3
- Dial Type Entry 4-19
- Dialing by REDIAL/PAUSE Key 2-21
- Dialing with Sub-address 4-50
- Direct Transmission Report Setting 4-54
- Direct TX by Default Setting 2-25

E

- ECM Setting 4-22
- Enabling or Disabling Send After Scan
 - Temporarily 4-35
- Entering Abbreviated Dialer Registration 4-8
- ENTERING CHARACTERS 4-3
- Entering Characters 4-5
- Entering One Touch Dialer Registration 4-10
- ENTERING
 - THE REMOTE FAX NUMBER 4-7
 - Entering to TEL LIST 4-7
- ENTERING VARIOUS FUNCTIONS 4-18
- Error Codes Printed on Reports 5-8
- Error Message 5-4
- e-STUDIO16 1-3
- e-STUDIO20/25 1-4
- Exchange Type Entry (EU MODEL ONLY) ... 4-20

F

- Fax Option List 4-60,4-85
- Features of the e-STUDIO16/20/25
 - FAX Functions 5
- For details on how to specify remote FAXes
 - using Multi-polling RX 3-26
- Function Keys 1-10
- Function List 4-60,4-84

G

- Group Broadcast Transmission 3-8
- Group Dialing 2-20
- Group Number List 4-82
- Groups Number Registration 4-12

H

- How to Set Image Density 2-12
- How to Set Image Quality Mode 2-11
- HOW TO SET SCANNING CONDITIONS 2-10
- How to Set the Resolution 2-10
- How to Switch Over to the FAX Mode 2-7

I

- Individual Polling RX 3-25

K

- Keypad Dialing 2-16
- Keys used for Character Entry 4-3

L

- Line Monitor 4-21
- List & Report Options Setting 4-52
- List and Report Print Format 4-61
- List and Report Printing Procedure 4-59
- Long Original Setting 4-47
- LOW SPEED TRANSMISSION 3-6

M

- MAILBOX (ITU-T COMPATIBLE) 3-9
- Mailbox/Relay Box List 4-60,4-75
- MAIN COMPONENTS 1-5

- Manual Image Density Mode
 - Setting Procedure 2-13
- MANUAL RECEIVE is selected: 2-33
- MEMORY RX 2-35
- Memory RX Setting 2-35
- Memory Transmission Report 4-65
- Memory Transmission Report Setting 4-55
- Memory TX 2-23
- Menu List (PROGRAM) 4-60,4-86
- MULTI-ADDRESS TRANSMISSION
 - (BROADCASTING) 3-7
- Multi-Address Transmission Report 4-66
- Multi-Address Transmission
 - Report Setting 4-56
- Multi-Key Quick Broadcast 3-7
- Multi-Polling Report 4-68
- Multi-Polling Report Setting 4-56

O

- Off-hook Dialing (External Telephone) 2-37
- Off-hook Transmission
 - (External Telephone Dialing) 2-27
- One Touch Dialing 2-21
- One Touch Number List 4-83
- On-hook Dialing 2-36
- On-hook Transmission 2-26
- Original Scanning Range 2-6
- Original Size 2-6
- OUTPUTTING LISTS & REPORTS 4-52
- Outputting Originals Stored in
 - the Memory 2-35

P

- Pause Key 2-17
- Pin Mask 4-49
- Placing the Originals on the Automatic
 - Document Feeder
 - (optional ADF or RADF is installed) 2-8
- POLLING COMMUNICATIONS 3-23
- Polling Reservation 3-23
- Power Failure List 4-87
- PRECAUTIONS 1-11
- Precautions When Feeding Originals 2-8

PREFACE	4
PREPARING FOR TRANSMISSION	2-9
Printing a Document from	
a Mailbox (Local Hub)	3-13
PRIORITY TRANSMISSION	
(PRIORITY TX)	3-4
Privileged Reception	4-45

R

RDC (Remote Diagnosis Configuration)	
Service	6-3
Receive Interval Setting	4-22
RECEIVING MODES	2-5
Reception Discard Setting	4-44
Reception Journal Setting	4-53
Reception List Setting	4-58
Reception Reduction Setting	4-44
Reception Trouble	5-7
RECEPTION-TYPES OF	
AUTO RECEPTION MODE	2-33
Redial Mode Setting	4-25
Relay Destination Report Setting	4-58
Relay Originator Report Setting	4-57
Relay Station Report	4-71
Relay Station Transmission	
Report Setting	4-57
RELAY TRANSMISSION	3-17
Relay Transmission Originator Report	4-70
Relay Transmission Relay End	
Terminal Report	4-74
Relay Transmission Relay Station Report	4-72
Relay Transmission to a Remote Hub	3-22
Relay Transmission, Relay-Relay	
Transmission Overview	3-17
Reservation List	4-59,4-77
Reserving a Document to a Mailbox	
(Local Hub)	3-12
Retrieving (Polling) a Document from	
a Mailbox (Remote Hub)	3-15
RTI (Remote Terminal ID) Print Setting	4-46

S

Secure RX Activation Period Setting	4-40
Secure RX Manual Activation	4-42
Secure RX Print	4-43
Secure RX Security Code Setting	4-39
Security TX (Transmission) Setting	4-27
Send After Scan Default Setting	4-34
SEND MODES	2-3
Sending a Document to a Mailbox	
(Remote Hub)	3-14
Sending a Tone	2-37
SENDING ORIGINALS (DIRECT TX)	2-24
SENDING ORIGINALS (MEMORY TX)	2-22
Sending Recovery Transmission	4-32
SENDING TWO-SIDED ORIGINALS	3-5
Separator Page Setting	4-38
Setting AUTO RECEIVE Modes	2-33
Setting Recovery Transmission	4-31
Setting Scanning Conditions for	
Each Page	2-14
Setting the Page Count	4-48
SETTING THE SCANNING CONDITIONS	
FOR EACH PAGE	2-14
Setting Up a Relay Box	3-19
Setting Up an Open Mailbox	3-10
Special Character Table	4-4
SPECIFICATIONS	7-3
SPECIFYING THE REMOTE FAX	2-16

T

Tel List	4-59
Temporary Direct TX	2-25
Temporary ECM Change	4-23
Temporary Line Monitor Change	4-21
Temporary Security TX Change	4-27
Terminal ID Entry	4-18
Tone Key	2-17
Transmission Report	4-64
Transmission Trouble	5-6
Transmission/Reception Journal	4-61
TROUBLESHOOTING	5-3
TTI (Transmit Terminal ID) Print Setting	4-33
Turnaround Polling	3-27

U

USING THE TELEPHONE 2-36

W

When a Power Failure Occurs 11

When the Graphic Symbols Flash 5-3

2231315EN
GD1060_Fax_REL2_UK.pdf
GD1060 Fax Manual UK

TOSHIBA

Toshiba Tec Germany Imaging Systems GmbH
Carl-Schurz-Str. 7
41460 Neuss
Telefon +49/(0)2131/1245-0
Fax +49/(0)2131/1245-402
[www. toshiba-europe.com](http://www.toshiba-europe.com)